

MODULAR WORKBENCHES

Beta has launched the new range of workbenches, MODULAR, designed to make it possible for professionals to configure their workplaces from scratch, adapting them to their individual needs.

The range comes in a wide choice of **preassembled combinations**; alternatively, you can fully **customize** your configuration, including the worktops, legs, mobile roller cabs and tool chests, tool wall systems and accessories.

The 75-cm-deep worktop means having a large, convenient, functional work surface available. It can be fitted with a vice, thereby allowing heavy-duty jobs to be carried out.

The new MODULAR range, designed according to the latest ergonomics studies, is enhanced by Beta's well-known sturdiness and quality, thereby standing out as an essential work partner.



Configure your workshop online



go to www.beta-tools.com

TOOL CHEST



TOOL WALL SYSTEMS



WORKTOPS



LEGS

C58BC-W1,6

simple workbench with wood worktop, 1.6 m long

Main features:

- Worktop (1,600x750 mm), made from multi-ply wood, 38 mm thick
- Steel frame with 4 supporting legs
- Holes for a vice (1599F/150 - 1599GI/150, to be ordered separately)
- Lower half-shelf for objects, 288x335 mm; thickness: 40 mm
- Can be fixed to floor
- Static load capacity: 1,000 kg, evenly distributed

Following accessories can be added:

- Perforated side panel C58PFL
- Anti-fall edge, 1,600 mm, C58BAC 1,6

61 kg

1000 kg

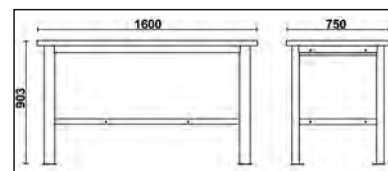

C58BC-W1,6

1 058000601

C58BC-X1,6

simple workbench with worktop made from stainless steel coated MDF, 1.6 m long

Main features:

- Worktop (1,600x750 mm) made from stainless steel coated MDF, 38 mm thick
- Steel frame with 4 supporting legs
- Holes for a vice (1599F/150 - 1599GI/150, to be ordered separately)
- Lower half-shelf for objects, 1,288x335 mm; thickness: 40 mm
- Can be fixed to floor
- Static load capacity: 1,000 kg, evenly distributed

Following accessories can be added:

- Perforated side panel C58PFL
- Anti-fall edge, 1,600 mm, C58BAC 1.6

74 kg

1000 kg

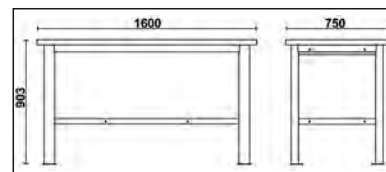

C58BC-X1,6

1 058000606

C58BC-W1,6 2C

workbench, 1.6 m long, with wood worktop and 2 drawers

Main features:

- Worktop (1,600x750 mm) made from multi-ply wood, 38 mm thick
- 2 drawers (367x588 mm) with ball bearing slides:
 - 1 drawer 70 mm high
 - 1 drawer 140 mm high.
- Drawer bases protected by foamed rubber mats
- Each drawer can accommodate up to 4 EVA foam or ABS thermoformed trays
- Front centralized lock
- Steel frame with 4 supporting legs
- Holes for a vice (1599F/150 - 1599GI/150, to be ordered separately)
- Lower half-shelf for objects, 1,288x335 mm; thickness: 40 mm
- Can be fixed to floor
- Static load capacity: 1,000 kg, evenly distributed

Following accessories can be added:

- Perforated side panel C58PFL
- Anti-fall edge, 1,600 mm, C58BAC 1.6

103,5 kg

1000 kg



h	max
70 mm	25 kg
140 mm	30 kg

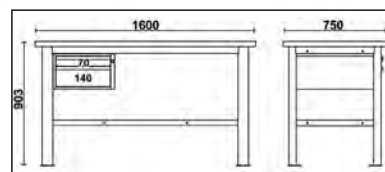

C58BC-W1,6 2C/O

1 058000611

C58BC-W1,6 2C/A

1 058000613

C58BC-W1,6 4C

workbench, 1.6 m long with wood worktop and 4 drawers

Main features:

- Worktop (1,600x750 mm) made from multi-ply wood, 38 mm thick
- 4 drawers (367x588 mm) with ball bearing slides:
 - 1 drawer 210 mm high
 - 3 drawers 70 mm high.
- Drawer bases protected by foamed rubber mats
- Each drawer can accommodate up to 4 EVA foam or ABS thermoformed trays
- Front centralized lock
- Steel frame with 4 supporting legs
- Holes for a vice (1599F/150 - 1599GI/150, to be ordered separately)
- Lower half-shelf for objects, 1,288x335 mm; thickness: 40 mm
- Can be fixed to floor
- Static load capacity: 1,000 kg, evenly distributed

Following accessories can be added:

- Perforated side panel C58PFL
- Anti-fall edge, 1,600 mm, C58BAC 1.6

1000
kg

RAL 2011



82 kg

RAL 7016



h	max
70 mm	25 kg
210 mm	30 kg

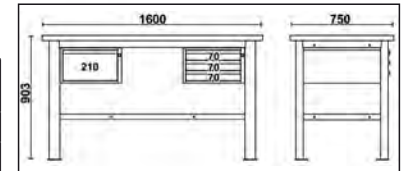

C58BC-W1,6 4C/O

1

058000612

C58BC-W1,6 4C/A

1

058000614

C58BC-W2,1

simple workbench with wood worktop, 2.1 m long

Main features:

- Worktop (2,100x750 mm) made from multi-ply wood, 38 mm thick
- Steel frame with 4 supporting legs
- Holes for a vice (1599F/150 - 1599GI/150, to be ordered separately)
- Lower half-shelf for objects, 1,788x335 mm; thickness: 40 mm
- Can be fixed to floor
- Static load capacity: 800 kg, evenly distributed

Following accessories can be added:

- Perforated side panel C58PFL
- Anti-fall edge, 2,100 mm, C58BAC 2.1

800
kg



70 kg

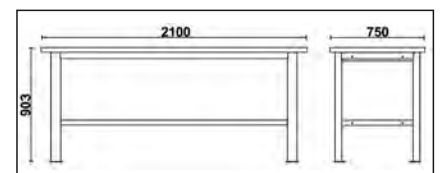

C58BC-W2,1

1

058000621

C58BC-X2,1

simple workbench with worktop made from stainless steel coated MDF, 2.1 m long

Main features:

- Worktop (2,100x750 mm) made from stainless steel coated MDF, 38 mm thick
- Steel frame with 4 supporting legs
- Holes for a vice (1599F/150 - 1599GI/150, to be ordered separately)
- Lower half-shelf for objects, 1,788x335 mm; thickness: 40 mm
- Can be fixed to floor
- Static load capacity: 1,000 kg, evenly distributed

Following accessories can be added:

- Perforated side panel C58PFL
- Anti-fall edge, 2,100 mm, C58BAC 2.1

93 kg

800 kg

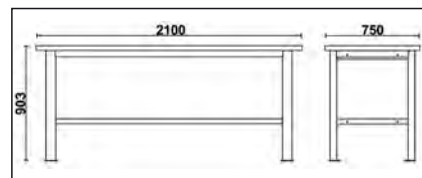

C58BC-X2,1

1 058000626

C58BC-W2,1 2C

workbench, 2.1 m long, with wood worktop and 2 drawers

Main features:

- Worktop (2,100x750 mm) made from multi-ply wood, 38 mm thick
- 2 drawers (367x588 mm) with ball bearing slides:
 - 1 drawer 70 mm high
 - 1 drawer 140 mm high.
- Drawer bases protected by foamed rubber mats
- Each drawer can accommodate up to 4 EVA foam or ABS thermoformed trays
- Front centralized lock
- Steel frame with 4 supporting legs
- Holes for a vice (1599F/150 - 1599GI/150, to be ordered separately)
- Lower half-shelf for objects, 1,788x335 mm; thickness: 40 mm
- Can be fixed to floor
- Static load capacity: 800 kg, evenly distributed

Following accessories can be added:

- Perforated side panel C58PFL
- Anti-fall edge, 2,100 mm, C58BAC 2.1

91 kg

800 kg



h	max
70 mm	25 kg
140 mm	30 kg

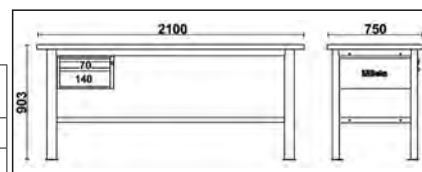

C58BC-W2,1 2C/O

1 058000631

C58BC-W2,1 2C/A

1 058000636

C58BC-W2,1 4C

workbench, 2.1 m long, with wood worktop and 4 drawers

Main features:

- Worktop (2,100x750 mm) made from multi-ply wood, 38 mm thick
- 4 drawers (367x588 mm) with ball bearing slides:
 - 2 drawers 70 mm high
 - 2 drawers 140 mm high.
- Drawer bases protected by foamed rubber mats
- Each drawer can accommodate up to 4 EVA foam or ABS thermoformed trays
- Front centralized lock
- Steel frame with 4 supporting legs
- Holes for a vice (1599F/150 - 1599GI/150, to be ordered separately)
- 2 lower half-shelves for objects, 1,788x335 mm; thickness: 40 mm
- Static load capacity: 800 kg, evenly distributed
- Can be fixed to floor

Following accessories can be added:

- Perforated side panel C58PFL
- Anti-fall edge, 2,100 mm, C58BAC 2.1

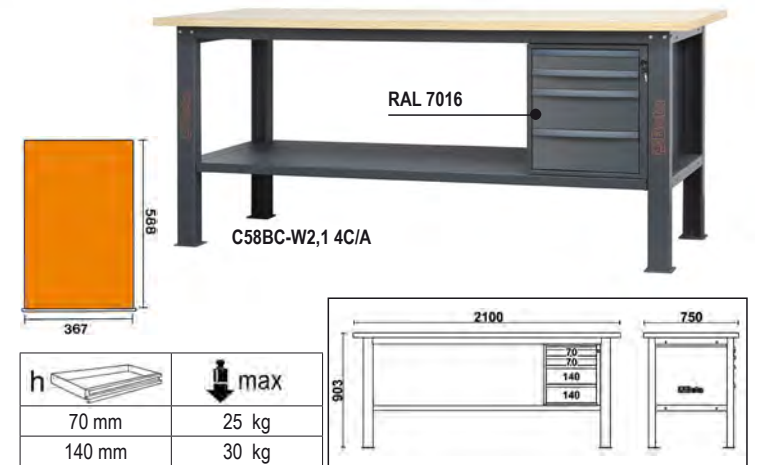
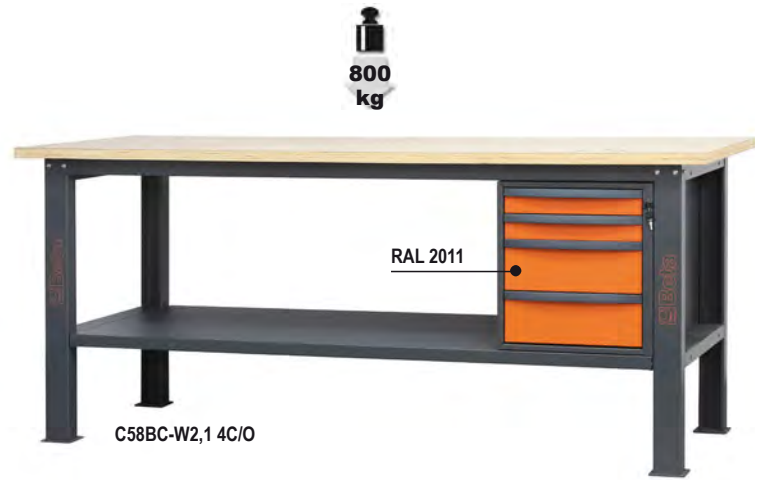

C58BC-W2,1 4C/O	1	058000632
C58BC-W2,1 4C/A	1	058000637

C58BC-W2,1 4CA

workbench, 2.1 m long, with wood worktop, 4 drawers and door module

Main features:

- Worktop (2,100x750 mm) made from multi-ply wood, 38 mm thick
- 4 drawers (367x588 mm) with ball bearing slides:
 - 2 drawers 70 mm high
 - 2 drawers 140 mm high.
- Drawer bases protected by foamed rubber mats
- Each drawer can accommodate up to 4 EVA foam or ABS thermoformed trays
- Front centralized lock
- 1 module with door and lock
- Steel frame with 4 supporting legs
- Holes for a vice (1599F/150 - 1599GI/150, to be ordered separately)
- 2 lower half-shelves for objects, 1,788x335 mm; thickness: 40 mm
- Static load capacity: 800 kg, evenly distributed
- Can be fixed to floor

Following accessories can be added:

- Perforated side panel C58PFL
- Anti-fall edge, 2,100 mm, C58BAC 2.1

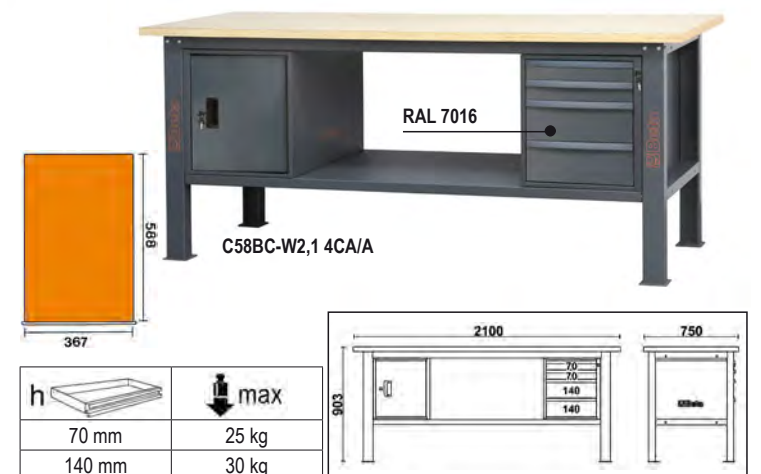

C58BC-W2,1 4CA/O	1	058000633
C58BC-W2,1 4CA/A	1	058000638

C58BC-W2,1 6CA

workbench, 2.1 m long, with wood worktop, 6 drawers and door module

Main features:

- Worktop (2,100x750 mm) made from multi-ply wood, 38 mm thick
- 6 drawers (367x588 mm) with ball bearing slides:
 - 1 drawer 210 mm high
 - 4 drawers 70 mm high
 - 1 drawer 140 mm high.
- Drawer bases protected by foamed rubber mats
- Each drawer can accommodate up to 4 EVA foam or ABS thermoformed trays
- Front centralized lock
- 1 module with door and lock
- Steel frame with 4 supporting legs
- Holes for a vice (1599F/150 - 1599GI/150, to be ordered separately)
- 2 lower half-shelves for objects, 1,788x335 mm; thickness: 40 mm
- Static load capacity: 800 kg, evenly distributed
- Can be fixed to floor

Following accessories can be added:

- Perforated side panel C58PFL
- Anti-fall edge, 2,100 mm, C58BAC 2.1

162 kg

C58BC-W2,1 6CA/O	1	058000634
C58BC-W2,1 6CA/A	1	058000639

800 kg



C58BC-W2,1 6CA/O



C58BC-W2,1 6CA/A



h	max
70 mm	25 kg
140 mm	30 kg
210 mm	30 kg

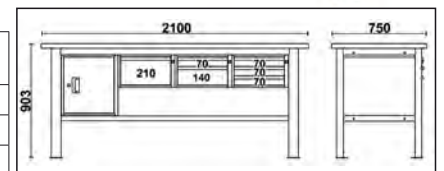

C58BC-W2,1 8CA

workbench, 2.1 m long, with wood worktop, 8 drawers and door module

Main features:

- Worktop (2,100x750 mm) made from multi-ply wood, 38 mm thick
- 8 drawers (367x588 mm) with ball bearing slides:
 - 5 drawers 70 mm high
 - 2 drawers 140 mm high
 - 1 drawer 210 mm high.
- Drawer bases protected by foamed rubber mats
- Each drawer can accommodate up to 4 EVA foam or ABS thermoformed trays
- Front centralized lock
- 1 module with door and lock
- Steel frame with 4 supporting legs
- Holes for a vice (1599F/150 - 1599GI/150, to be ordered separately)
- 2 lower half-shelves for objects, 1,788x335 mm; thickness: 40 mm
- Static load capacity: 800 kg, evenly distributed
- Can be fixed to floor

Following accessories can be added:

- Perforated side panel C58PFL
- Anti-fall edge, 2,100 mm, C58BAC 2.1

174 kg

C58BC-W2,1 8CA/O	1	058000635
C58BC-W2,1 8CA/A	1	058000640

800 kg



C58BC-W2,1 8CA/O



C58BC-W2,1 8CA/A



h	max
70 mm	25 kg
140 mm	30 kg
210 mm	30 kg

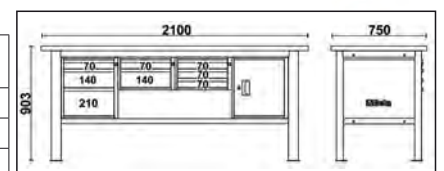

C58BC-X2,1 4C

workbench, 2.1 m long, with worktop made from stainless steel coated MDF and 4 drawers

Main features:

- Worktop (2,100x750 mm) made from stainless steel coated MDF, 38 mm thick
- 4 drawers (367x588 mm) with ball bearing slides:
 - 2 drawers 70 mm high
 - 2 drawers 140 mm high.
- Drawer bases protected by foamed rubber mats
- Each drawer can accommodate up to 4 EVA foam or ABS thermoformed trays
- Front centralized lock
- Steel frame with 4 supporting legs
- Holes for a vice (1599F/150 - 1599GI/150, to be ordered separately)
- 2 lower half-shelves for objects, 1,788x335 mm; thickness: 40 mm
- Static load capacity: 800 kg, evenly distributed
- Can be fixed to floor

Following accessories can be added:

- Perforated side panel C58PFL
- Anti-fall edge, 2,100 mm, C58BAC 2.1

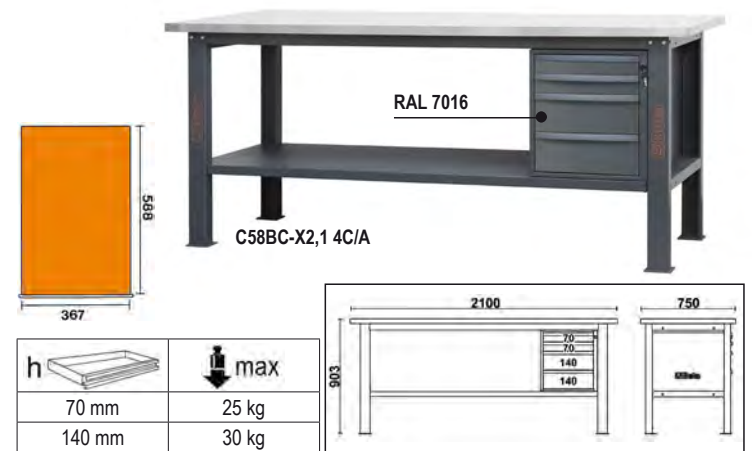

C58BC-X2,1 4C/O	1	058000623
C58BC-X2,1 4C/A	1	058000627

C58BC-X2,1 4CA

workbench, 2.1 m long, with worktop made from stainless steel coated MDF, 4 drawers and door module

Main features:

- Worktop (2,100x750 mm) made from stainless steel coated MDF, 38 mm thick
- 4 drawers (367x588 mm) with ball bearing slides:
 - 2 drawers 70 mm high
 - 2 drawers 140 mm high.
- Drawer bases protected by foamed rubber mats
- Each drawer can accommodate up to 4 EVA foam or ABS thermoformed trays
- Front centralized lock
- 1 module with door and lock
- Steel frame with 4 supporting legs
- Holes for a vice (1599F/150 - 1599GI/150, to be ordered separately)
- 2 lower half-shelves for objects, 1,788x335 mm; thickness: 40 mm
- Static load capacity: 800 kg, evenly distributed
- Can be fixed to floor

Following accessories can be added:

- Perforated side panel C58PFL
- Anti-fall edge, 2,100 mm, C58BAC 2.1

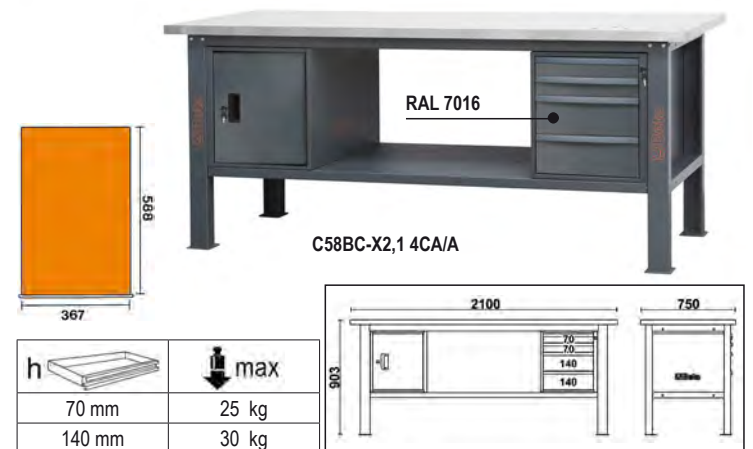

C58BC-X2,1 4CA/O	1	058000624
C58BC-X2,1 4CA/A	1	058000628

C58BC-X2,1 8CA

workbench, 2.1 m long, with worktop made from stainless steel coated MDF, 8 drawers, 8 drawers and door module

Main features:

- Worktop (2,100x750 mm) made from stainless steel coated MDF, 38 mm thick
- 8 drawers (367x588 mm) with ball bearing slides:
 - 5 drawers 70 mm high
 - 2 drawers 140 mm high
 - 1 drawer 210 mm high.
- Drawer bases protected by foamed rubber mats
- Each drawer can accommodate up to 4 EVA foam or ABS thermoformed trays
- Front centralized lock
- 1 module with door and lock
- Steel frame with 2 supporting legs
- Holes for a vice (1599F/150 - 1599GI/150, to be ordered separately)
- 2 lower half-shelves for objects, 1,788x335 mm; thickness: 40 mm
- Static load capacity: 800 kg, evenly distributed
- Can be fixed to floor

Following accessories can be added:

- Perforated side panel C58PFL
- Anti-fall edge, 2,100 mm, C58BAC 2.1

197 kg

C58BC-X2,1 8CA/O	1	058000625
C58BC-X2,1 8CA/A	1	058000629

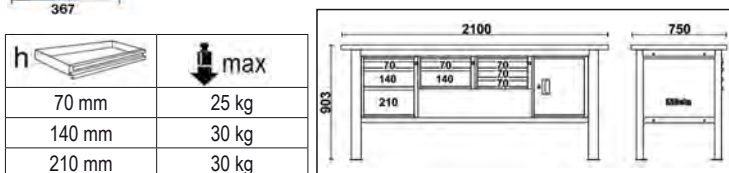

C58PLT-W 1,6

worktop (1,600x750 mm) made from multi-ply wood, for modular workbenches C58BC

- Thickness: 38 mm
- Holes for a vice (1599F/150 - 1599GI/150, to be ordered separately)

35,5 kg

C58PLT-W 1,6	1	058000641
--------------	---	-----------



C58PLT-X 1,6

worktop (1,600x750 mm) made from stainless steel coated MDF, for modular workbenches C58BC

- Thickness: 38 mm
- Holes for a vice (1599F/150 - 1599GI/150, to be ordered separately)

48,5 kg

C58PLT-X 1,6	1	058000646
--------------	---	-----------



C58PLT-W 2,1

worktop (2,100x750 mm) made from multi-ply wood, for modular workbenches C58BC

- Thickness: 38 mm
- Holes for a vice (1599F/150 - 1599GI/150, to be ordered separately)

41 kg

C58PLT-W 2,1	1	058000651
--------------	---	-----------



C58PLT-X 2,1

worktop (2,100x750 mm) made from stainless steel coated MDF, for modular workbenches C58BC

- Thickness: 38 mm
- Holes for a vice (1599F/150 - 1599GI/150, to be ordered separately)



63,5 kg

C58PLT-X 2,1

1 058000656

C58GF

fixed height leg, for modular workbenches C58BC

- Sturdy sheet metal frame, with holes for fixing shelves
- Height: 866 mm
- Can be fixed to floor
- Colour: anthracite grey RAL7016
- Carrying capacity: 400 kg

8 kg



C58GF

1 058000660

C58GT

vertically adjustable leg, for modular workbenches C58BC

Vertically adjustable height allows individual requirements to be satisfied, thereby translating into optimally ergonomic workbenches.

- Sturdy sheet metal frame, with holes for fixing shelves
- Height: 715 ÷ 1,065 mm; hole pitch: 25 mm
- Can be fixed to floor
- Colour: anthracite grey RAL7016
- Carrying capacity: 400 kg

10 kg



C58GT

1 058000661

C58GRGM

leg with steering castors and handle, for modular workbenches C58BC

- Sturdy sheet metal frame, with holes for fixing shelves
- 2 steering castors, Ø 125 mm, with brakes
- Side handle for convenient carrying of workbench
- Overall height: 824 mm, including castor
- Colour: anthracite grey RAL7016
- Carrying capacity: 400 kg

9,5 kg



C58GRGM

1 058000662

C58GRF

leg with fixed castors, for modular workbenches C58BC

- Sturdy sheet metal frame, with holes for fixing shelves
- 2 fixed castors, Ø 125 mm
- Overall height: 824 mm, including castor
- Colour: anthracite grey RAL7016
- Carrying capacity: 400 kg

8,5 kg



C58GRF

1 058000663

C58CS 1C

tool chest, 257 mm high, with 1 drawer, for modular workbenches C58BC

- 1 fully removable drawer (367x588 mm), with ball bearing slides, 210 mm high
- Front centralized safety lock
- Drawer base protected by foamed rubber mat
- Each drawer can accommodate up to 4 EVA foam or ABS thermoformed trays



18,5 kg

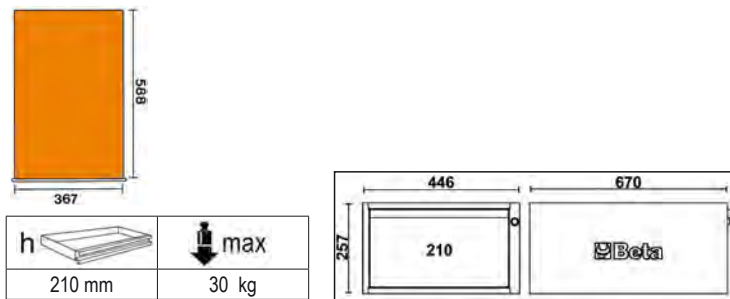

C58CS/O 1C	1	058000671
C58CS/A 1C	1	058000674

C58CS 2C

tool chest, 257 mm high, with 2 drawers, for modular workbenches C58BC

- 2 fully removable drawers (367x588 mm), with ball bearing slides:
- 1 drawer 70 mm high
- 1 drawer 140 mm high
- Front centralized safety lock
- Drawer bases protected by foamed rubber mats
- Each drawer can accommodate up to 4 EVA foam or ABS thermoformed trays



21 kg

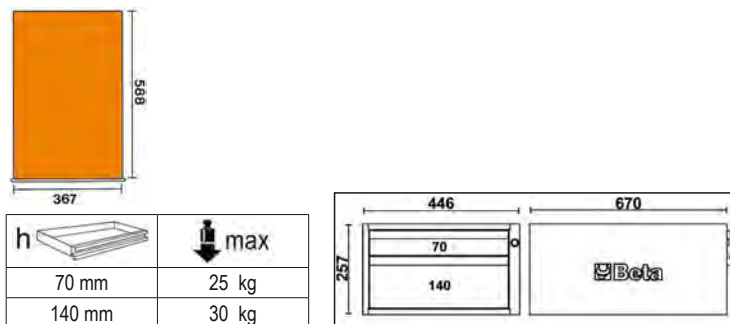

C58CS/O 2C	1	058000672
C58CS/A 2C	1	058000675

C58CS 3C

tool chest, 257 mm high, with 3 drawers, for modular workbenches C58BC

- 3 fully removable drawers (367x588 mm), with ball bearing slides, 70 mm high
- Front centralized safety lock
- Drawer bases protected by foamed rubber mats
- Each drawer can accommodate up to 4 EVA foam or ABS thermoformed trays



24 kg

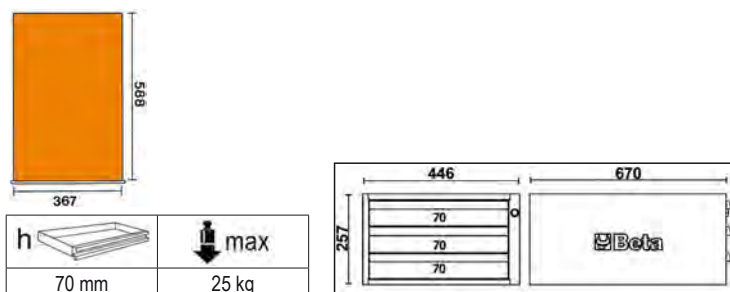

C58CS/O 3C	1	058000673
C58CS/A 3C	1	058000676

C58MA

module, 479 mm high, with door, for modular workbenches C58BC

- Front safety lock
- Sheet metal door can be installed with right or left opening
- Usable interior dimensions: 440x640x447 mm

15 kg

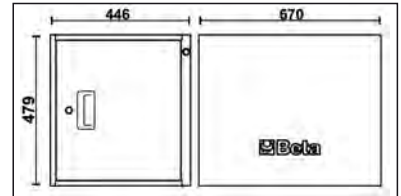

C58MA/O	1	058000680
C58MA/A	1	058000681

C58CSH 3C

tool chest, 479 mm high, with 3 drawers, for modular workbenches C58BC

- 3 fully removable drawers (367x588 mm), with ball bearing slides:
 - 1 drawer 70 mm high
 - 1 drawer 140 mm high
 - 1 drawer 210 mm high
- Front centralized safety lock
- Drawer bases protected by foamed rubber mats
- Each drawer can accommodate up to 4 EVA foam or ABS thermoformed trays

31 kg

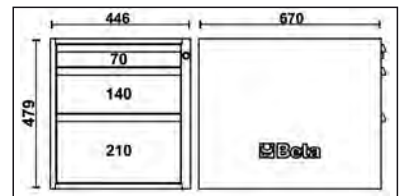

h	max
70 mm	25 kg
140 mm	30 kg
210 mm	30 kg

C58CSH/O 3C	1	058000682
C58CSH/A 3C	1	058000686

C58CSH 4C

tool chest, 479 mm high, with 4 drawers, for modular workbenches C58BC

- 4 fully removable drawers (367x588 mm), with ball bearing slides:
 - 2 drawers 70 mm high
 - 2 drawers 140 mm high
- Front centralized safety lock
- Drawer bases protected by foamed rubber mats
- Each drawer can accommodate up to 4 EVA foam or ABS thermoformed trays

35 kg

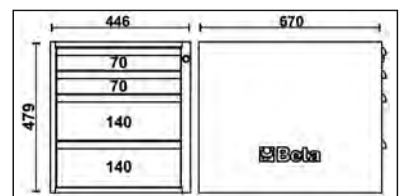

h	max
70 mm	25 kg
140 mm	30 kg

C58CSH/O 4C	1	058000683
C58CSH/A 4C	1	058000687

C58CSH 5C

tool chest, 479 mm high, with 5 drawers, for modular workbenches C58BC

- 5 fully removable drawers (367x588 mm), with ball bearing slides:
 - 4 drawers 70 mm high
 - 1 drawer 140 mm high
- Front centralized safety lock
- Drawer bases protected by foamed rubber mats
- Each drawer can accommodate up to 4 EVA foam or ABS thermoformed trays

37,5 kg



RAL 2011

C58CSH/O 5C

RAL 7016

C58CSH/A 5C

C58CSH/O 5C	1	058000684
C58CSH/A 5C	1	058000688

h	max
70 mm	25 kg
140 mm	30kg

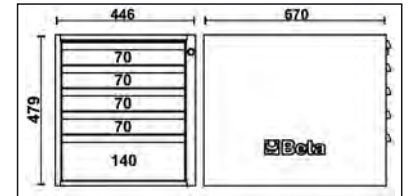

C58CSH 6C

tool chest, 479 mm high, with 6 drawers, for modular workbenches C58BC

- 6 fully removable drawers (367x588 mm), with ball bearing slides, 70 mm high
- Front centralized safety lock
- Drawer bases protected by foamed rubber mats
- Each drawer can accommodate up to 4 EVA foam or ABS thermoformed trays

40 kg



RAL 2011

C58CSH/O 6C

RAL 7016

C58CSH/A 6C

C58CSH/O 6C	1	058000685
C58CSH/A 6C	1	058000689

h	max
70 mm	25 kg

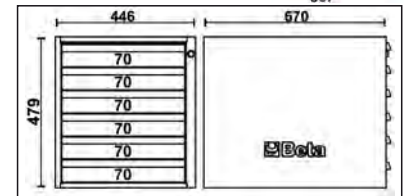

C58K/2PF-1,6M

kit of 2 perforated tool panels with frames, for modular workbenches C58BC, 1.6 m long

Kit contents:

- 3 supporting brackets
- 3 400-mm uprights
- 2 765-mm supports; can accommodate 1 19" rack multi-socket (not included)
- 2 perforated tool panels, 765x25x400 mm

14,4 kg

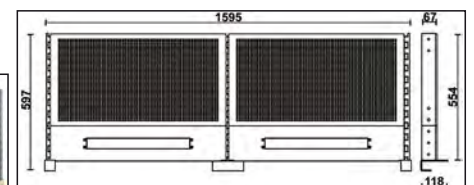
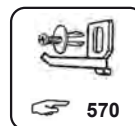

C58K/2PF-1,6M	1	058000802
---------------	---	-----------

C58K/4PF-1,6M

kit of 4 perforated tool panels with frames, for modular workbenches
C58BC, 1.6 m long

Kit contents:

- 3 supporting brackets
- 6 400-mm uprights
- 2 765-mm supports; can accommodate 1 19" rack multi-socket (not included)
- 4 perforated tool panels, 765x400 mm

23,9 kg

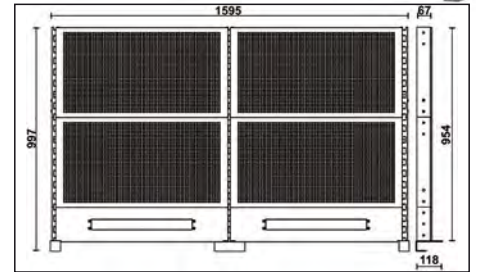
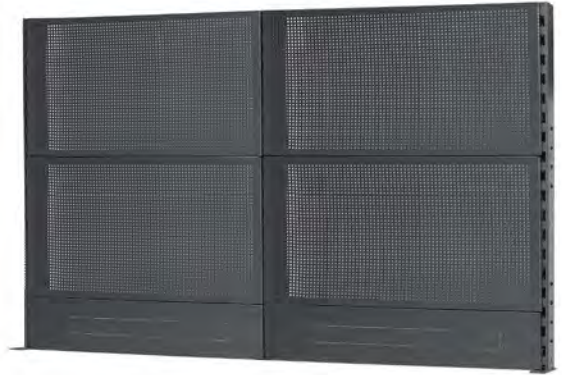
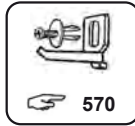

C58K/4PF-1,6M

1 058000804

C58K/2PF-2,1M

kit of 2 perforated tool panels with frames, for modular workbenches
C58BC, 2.1 m long

Kit contents:

- 3 supporting brackets
- 3 400-mm uprights
- 2 1,015-mm supports; can accommodate 1 19" rack multi-socket (not included)
- 2 perforated tool panels, 1,015x25x400 mm

17 kg

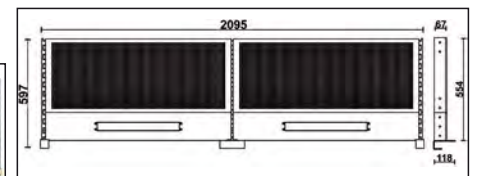
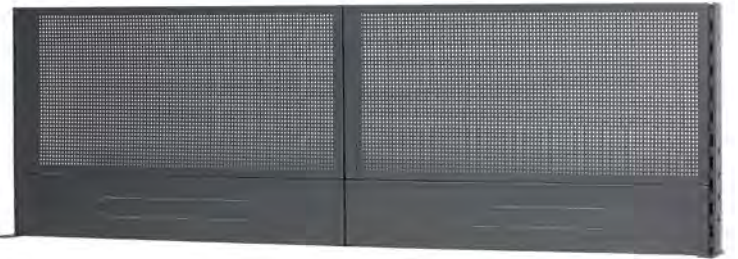

C58K/2PF-2,1M

1 058000812

C58K/4PF-2,1M

kit of 4 perforated tool panels with frames, for modular workbenches
C58BC, 2.1 m long

Kit contents:

- 3 supporting brackets
- 6 400-mm uprights
- 2 1,015-mm supports; can accommodate 1 19" rack multi-socket (not included)
- 4 perforated tool panels, 1,015x25x400 mm

28,2 kg

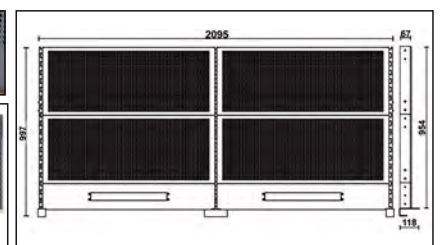
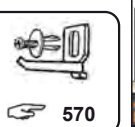

C58K/4PF-2,1M

1 058000814

C58SP 1,6

supporting half-shelf, for modular workbenches C58BC, 1.6 m long

- Thickness: 40 mm
- Fixing material included

9,7 kg



C58SP 1,6

1 058000690

C58SP 2,1

supporting half-shelf, for modular workbenches C58BC, 2.1 m long

- Thickness: 40 mm
- Fixing material included

13,3 kg



C58SP 2,1

1 058000691

C58BAC 1,6

anti-fall edge for modular workbenches C58BC, 1.6 m long

- Can accommodate 2 electrical outlets and 1 19" rack multi-socket (not included)
- Dimensions: 1,600x55x120 mm

4,5 kg



C58BAC 1,6

1 058000692

C58BAC 2,1

anti-fall edge for modular workbenches C58BC, 2.1 m long

- Can accommodate 2 electrical outlets and 1 19" rack multi-socket (not included)
- Dimensions: 2.100x55x120 mm

5,8 kg



C58BAC 2,1

1 058000693

C58PFL

perforated side panel for modular workbenches C58BC

- Dimensions: 560x25x545 mm
- Fixing material included

1,8 kg



C58PFL

1 058000696

C58MP-0,8M

shelf for modular workbenches C58BC, 1,6 m long

- Dimensions: 774x335 mm
- Designed for application of aluminium profiles with LED strip item 5000 RSC50 2.0/PLEDC or 5000 RSC50 2.0/PLED-ST (to be ordered separately), to light under-workbench modules

3,5 kg



C58MP-0,8M

1 058000840

C58MP-1M

shelf for modular workbenches C58BC, 2,1 m long

- Dimensions: 1,024x335 mm
- Designed for application of aluminium profiles with LED strip item 5000 RSC50 2.0/PLEDC or 5000 RSC50 2.0/PLED-ST (to be ordered separately), to light under-workbench modules

4,5 kg



C58MP-1M

1 058000841

C58BLP-1,6M

LED lamp track, for modular workbenches C58BC, 1,6 m long

- Frame length: 1,550 mm
- Can be supplied with 1 LED lamp item C58PLED-150 (to be ordered separately)

5,2 kg



C58BLP-1,6M

1 058000850

C58BLP-1M

LED lamp track, for modular workbenches, C58BC 2,1 m long

- Frame length: 1,024 mm
- Can be supplied with 1 LED lamp item C58PLED-90 (to be ordered separately) • To complete the set-up of the 2.1 m bench, 2 units must be ordered

3,8 kg



C58BLP-1M

1 058000851

C58PLED-150

LED lamp for modular workbenches C58BC, 1,6 m long

- Dimensions: 1,500x25x78 mm
- Power: 48W
- Brightness: 4,320 lumens
- Light temperature: 6400k
- Light beam: 180°
- Degree of protection: IP20
- Average life: >20,000 hours
- Operating temperature: -10 °C ÷ +45 °C
- Operating voltage: 220-240AC, 50/60 Hz
- Supplied with fixing clips

540 g



CC

C58PLED-150

1 058000860

C58PLED-90

LED lamp for modular workbenches C58BC, 2.1 m long

CE

- Dimensions: 900x23x75 mm
- Power: 24W
- Brightness: 2,200 lumens
- Light temperature: 6400k
- Light beam: 180°
- Degree of protection: IP20
- Average life: >20,000 hours
- Operating temperature: -10 °C ÷ +45 °C
- Operating voltage: 220-240AC, 50/60 Hz
- Supplied with fixing clips



340 g

C58PLED-90

1 058000861

C56

workbench

- Worktop made of painted sheet metal with external edge
- Steel frame with 6 supporting legs
- Static load capacity: 1200 kg
- Matches panel toolholder C57P; cannot be fixed to worktop
- Two drawers with lock
- Can be fixed to floor

82 kg



C56-O	RAL 2011	1	056000201
C56-G	RAL 7016	1	056000202
C56-R	RAL 3000	1	056000203

C56W

workbench with wood top

- Multi-ply wood worktop with holes for a vice (1599F/125 - 1599GI/125, to be ordered separately).
- Steel frame with 6 supporting legs
- Static load capacity: 1,200 kg
- Matches panel tool holder C57P; cannot be fixed to worktop.
- Two drawers with locks.
- Can be fixed to floor.

86 kg



C56W-O	RAL 2011	1	056000251
C56W-G	RAL 7016	1	056000252
C56W-R	RAL 3000	1	056000253

C59A

"Endurance" workbench with 1 cab with six drawers

Main features:

- Worktop made from multi-ply wood with holes for vice item 1599F/125 - 1599GI/125 (to be ordered separately).
- 6 drawers (588x367 mm) with ball bearing slides:
 - 4 drawers, 70 mm high
 - 1 drawer, 140 mm high
 - 1 drawer, 280 mm high.
- Drawers protected by foamed rubber mats.
- Hard-wearing nylon drawer front.
- Roller cabs can accommodate thermoformed trays.
- Front centralized safety lock.
- Lower object shelf.
- Can be fitted with paper roll holder (2400 RSC24/PC) and bottle holder (2400 RSC24/PF-), to be ordered separately.

115 kg

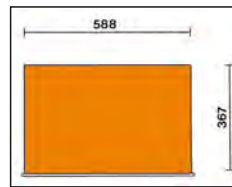

h	max
70 mm	25 kg
140 mm	30 kg
280 mm	35 kg

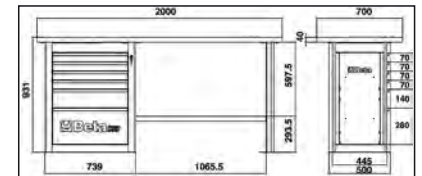

C59A-O	RAL 2011 - 7016	1	059000011
C59A-A	RAL 7016	1	059000031
C59A-R	RAL 3000 - 7016	1	059000051

C59B

"Endurance" workbench with 2 cabs with six drawers

Main features:

- Worktop made from multi-ply wood with holes for vice item 1599F/125 - 1599GI/125 (to be ordered separately).
- 12 drawers (588x367 mm) with ball bearing slides:
 - 8 drawers, 70 mm high
 - 2 drawers, 140 mm high
 - 2 drawers, 280 mm high.
- Drawers protected by foamed rubber mats.
- Can accommodate thermoformed trays.
- Front centralized safety lock.
- Lower object shelf.
- Can be fitted with paper roll holder (2400 RSC24/PC) and bottle holder (2400 RSC24/PF-), to be ordered separately.

155 kg

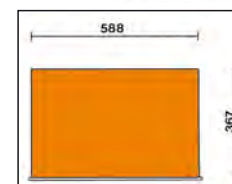
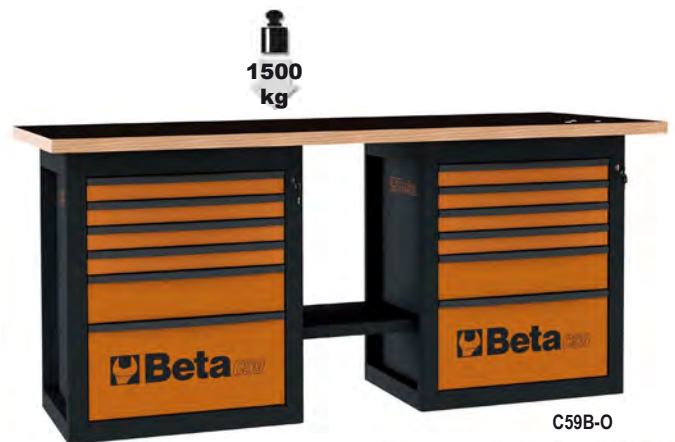

h	max
70 mm	25 kg
140 mm	30 kg
280 mm	35 kg

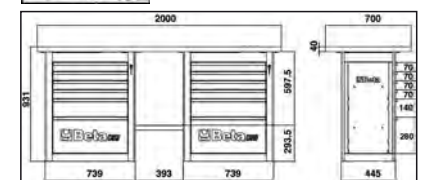

C59B-O	RAL 2011 - 7016	1	059000012
C59B-R	RAL 3000 - 7016	1	059000052
C59B-A	RAL 7016	1	059000032

"Endurance" workbench with 1 cab with six drawers, short model

Main features:

- Worktop made from multi-ply wood with holes for vice item 1599F/125 - 1599GI/125 (to be ordered separately).
- 6 drawers (588x367 mm) with ball bearing slides:
 - 4 drawers, 70 mm high
 - 1 drawer, 140 mm high
 - 1 drawer, 280 mm high.
- Drawers protected by foamed rubber mats.
- Can accommodate thermoformed trays.
- Front centralized safety lock.
- Lower object shelf.
- Can be fitted with paper roller holder (2400 RSC24/PC) and bottle holder (2400 RSC24/PF-), to be ordered separately.

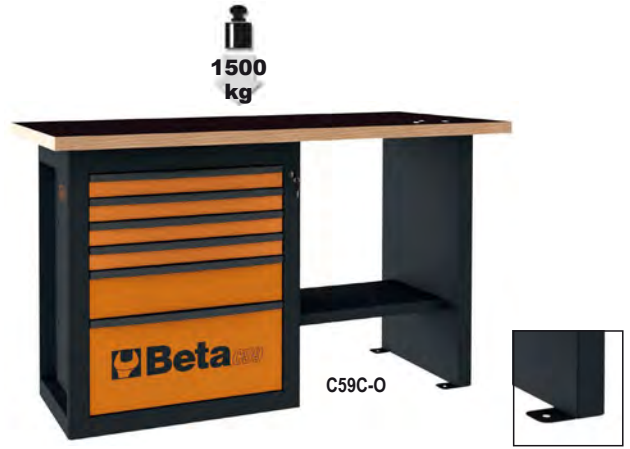

1500 kg

C59C-O



C59C-A



C59C-R

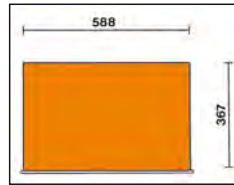

h	max
70 mm	25 kg
140 mm	30 kg
280 mm	35 kg

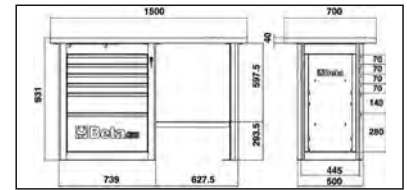

105 kg

C59C-O	RAL 2011 - 7016	1	059000013
C59C-R	RAL 3000 - 7016	1	059000053
C59C-A	RAL 7016	1	059000033





MODULAR MAT

	PCP	SCG/M	SCG/F
	6x	5x	5x
	8x	6x	6x
	10x	7x	7x

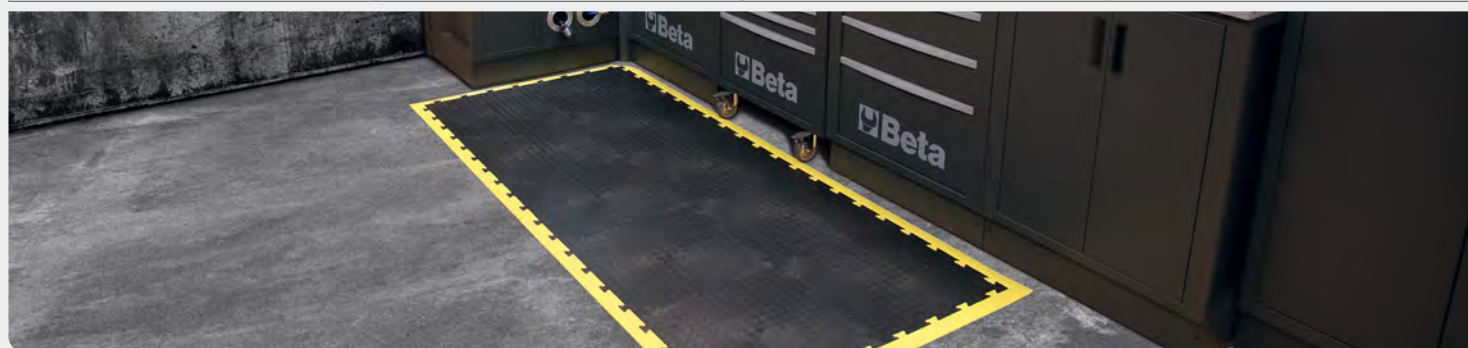

PCP

modular nonslip PVC tile

A perfect addition to Beta's workshop equipment combinations and workbenches.

Main features:

- Surface with "bubble" relief pattern
- Tested for fire resistance in accordance with EN 13501-1
- Anti-slip grade: R10, in accordance with DIN EN 16165
- Resistant to most solvents and chemicals
- Good soundproofing and heat insulation
- Easy to clean
- Joint assembly system

1,4 kg

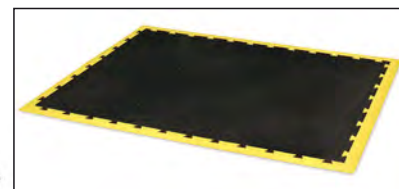
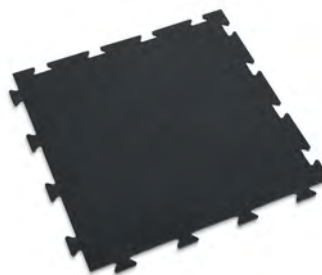

PCP 500x500x80 mm 10 088880800

SCG

modular PCP tile chute

A must-have for marking the boundaries of working areas.

Main features:

- Male or female jointed chute
- Each edge can be cut at an angle of 45°, to make a corner
- Yellow colour, for maximum visibility
- With slope, to make it easier for handling vehicles to go up

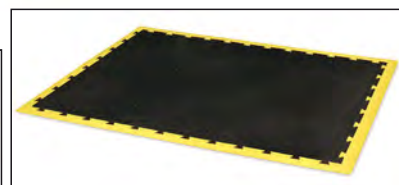

SCG/M 483x50x7,5 mm 10 088880805
SCG/F 483x50x7,5 mm 10 088880810



WORKSHOP EQUIPMENT RSC55



To answer the requirements of a market where the emphasis is increasingly on quality, design and customization, Beta Utensili has developed "Racing System C55", modular garage furniture shaped on your needs, while allowing you to create a modern work environment.



QUALITY

Beta's best Italian-made quality to furnish your garage



ORGANIZATION

A sensibly organized workstation, synonymous with optimized work



DESIGN

Refined, captivating finishes for a tidy, attractive workstation



MODULARITY

Modular garage fitting your spaces and requirements





WORKSHOP EQUIPMENT RSC55



MADE IN ITALY

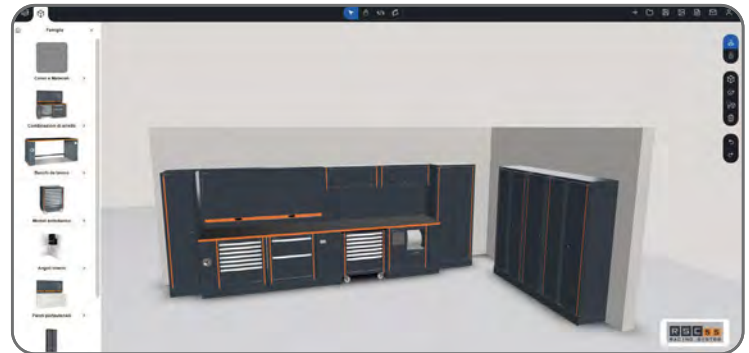

Configure your workshop online
Go to www.rsc55.com

YOUR COLOURS FOR YOUR WORKSHOP!

RSC55 allows you to order the benches and tool wall system with shutter in a neutral (grey) version and customize the vertical coloured inserts by choosing from 7 different adhesive tapes.

**Order the vertical insert
in a neutral colour**

Order the vertical insert

Choose the colour to your taste or according
to your company's colours



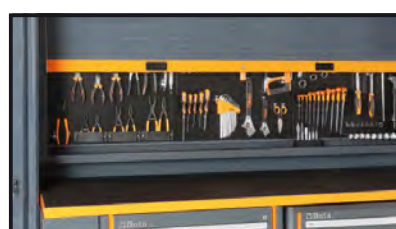
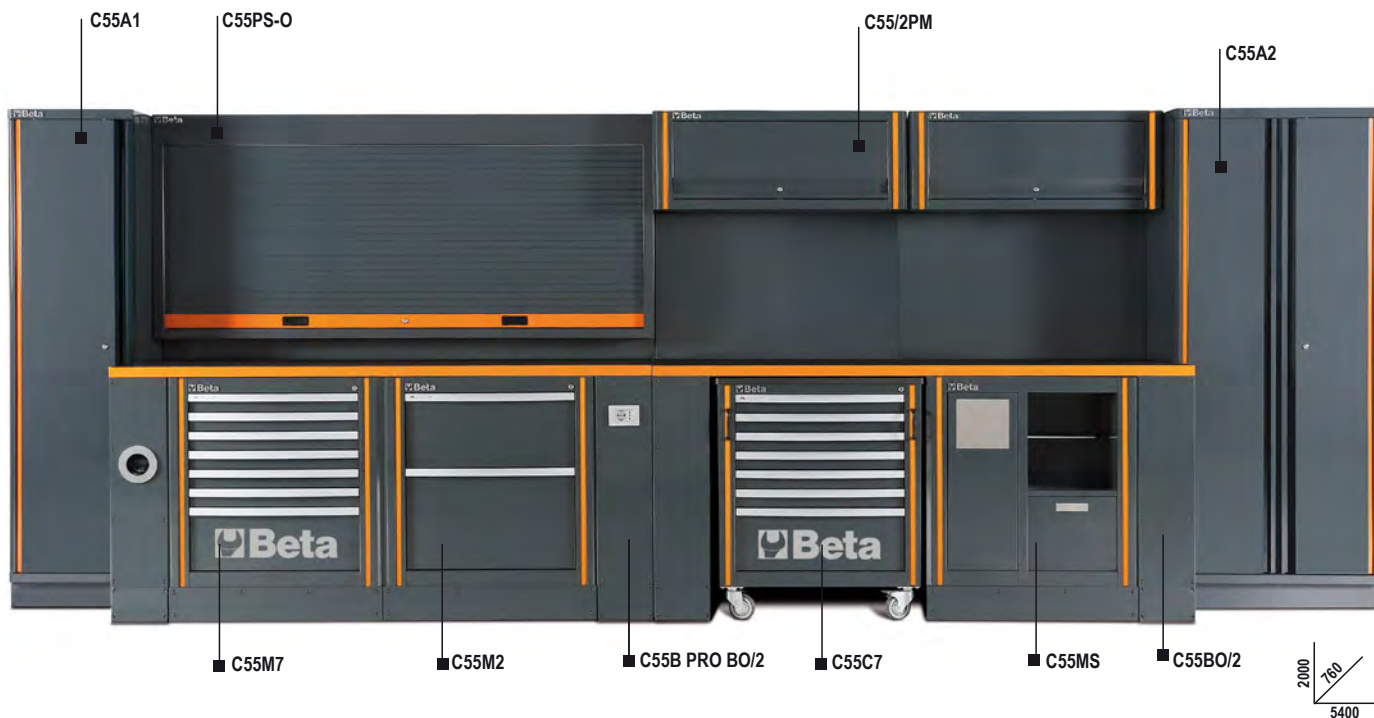

Comprehensive combination comprising:

- Single-door tool cabinet (C55A1)
- Two-door tool cabinet (C55A2)
- Workbench (C55BO/2)
- Workbench with sockets (C55PRO BO/2)
- Mobile roller cab with 7 drawers (C55C7)
- Fixed module with 2 storage drawers (C55M2)
- Fixed module with 7 drawers (C55M7)
- Fixed service module (C55MS)
- Tool panel with suspended cabinets (C55/2PM)
- Tool panel with shutter (C55PS-O)

C55AB

workshop equipment combination

Combination comprising:

- Two-door tool cabinet (C55A2)
- Workbench (C55BO/2)
- Fixed module with 7 drawers (C55M7)
- Fixed service module (C55MS)
- Tool panel with suspended cabinets (C55/2PM)

407 kg



C55AB

1 055000020



C55PB/3

workshop equipment combination

Combination comprising:

- Workbench (C55BO/2)
- Roller cab module with 8 drawers (C55C8)
- Fixed module with 2 storage drawers (C55M2)
- Wall tool system with shutter (C55PS-O)

334 kg



C55PB/3

1 055000035



C55PB-PRO/7

workstation for workshop equipment combination RSC55

Composed of:

C55B

Workbench with worktop (2050x700 mm) covered with a shockproof, nonscratch ABS coat resistant to oils and hydrocarbons.

Fitted with:

- Holes for a vice (1599F/150 - 1599GI/150, to be ordered separately)
- Vertically adjustable feet

C55M7

Fixed module with seven drawers (588x367 mm) with ball bearing slides

- Aluminium opening system throughout length of drawer
- Drawer bases protected by foamed rubber mats
- Front centralized lock
- Can be fitted with thermoformed trays

C55MS

Fixed service module

- Built-in waste bin
- Paper roll compartment
- Storage drawer, 305x270 mm

C55/2PM + C55/PF

Tool wall system with 2 suspended cabinets

- 2 suspended cabinets, 1024x400x300 mm, with gas springs
- 2 under-cabinet panels, 1024x620x25 mm
- 2 under-cabinet perforated tool panels, 1024x620x25 mm

350 kg

C55PB-PRO/7

1 055000065



C55PB-PRO/8

workstation for workshop equipment combination RSC55

Composed of:

C55B

Workbench with worktop (2050x700 mm) covered with a shockproof, nonscratch ABS coat resistant to oils and hydrocarbons.

Fitted with:

- Holes for a vice (1599F/150 - 1599GI/150, to be ordered separately)
- Vertically adjustable feet

C55C7

Mobile roller cab with seven drawers (588x367 mm) with ball bearing slides

- 4 castors Ø 100 mm, 2 fixed and 2 steering (one with brake)
- Aluminium opening system throughout length of drawer
- Drawer bases protected by foamed rubber mats
- Front centralized lock
- Can be fitted with thermoformed trays

C55MA

Fixed two-door module

- Push-pull opening system
- With lock
- Interior shelf, vertically adjustable

C55PS

Tool wall system with shutter and framework

- Aluminium shutter, vertically adjustable, with lock
- Removable perforated tool panel

347 kg

C55PB-PRO/8

1 055000066



C55B/2

2-m-long workbench, for workshop equipment combination

With worktop (2050x700 mm) covered with a shockproof, non-scratch PVC coat, resistant to hydrocarbons

- Holes for a vice (1599F/150 - 1599GI/150, to be ordered separately)
- Vertically adjustable feet

105 kg

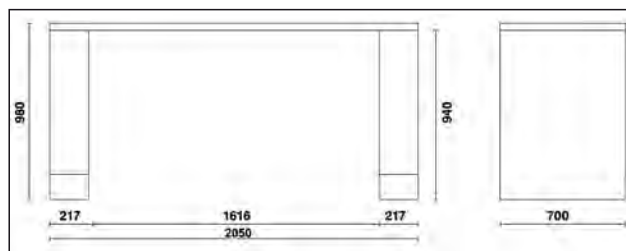
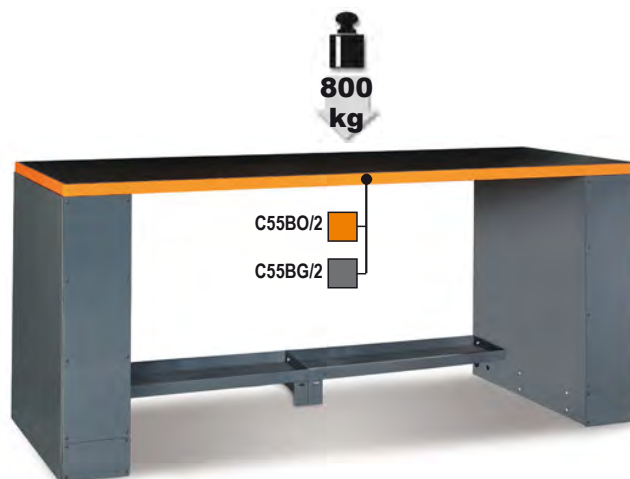

C55BO/2	1	055000101
C55BG/2	1	055000111

C55PRO B/2

2-m-long workbench, for workshop equipment combination

With worktop (2050x700 mm) covered with a shockproof, non-scratch PVC coat, resistant to hydrocarbons

Built-in sockets and hose reel:

- Schuko socket +16+10A
- EU Plug 10A
- Compressed air outlet with hose reel, Ø 8 mm, hose length: 10 m.
- Holes for a vice (1599F/150 - 1599GI/150, to be ordered separately)
- Vertically adjustable feet

110 kg

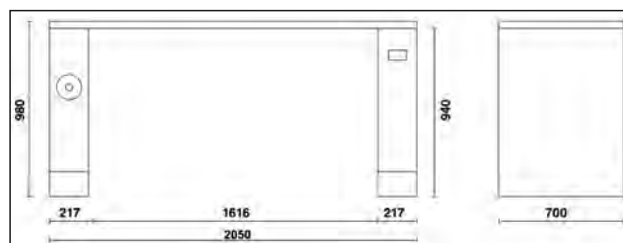
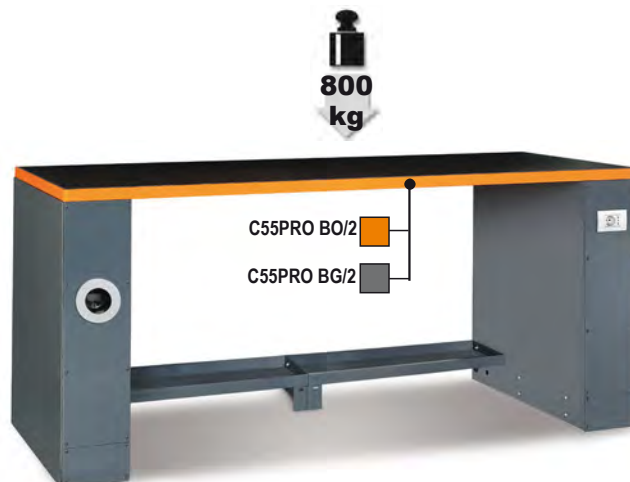

C55PRO BO/2	1	055000151
C55PRO BG/2	1	055000171

C55B/2,8

2.8-m-long workbench, for workshop equipment combination

Worktop (2850x700 mm) covered with a shockproof, non-scratch PVC coat, resistant to hydrocarbons

- Holes for a vice (1599F/150 - 1599GI/150, to be ordered separately)
- Vertically adjustable feet

131 kg

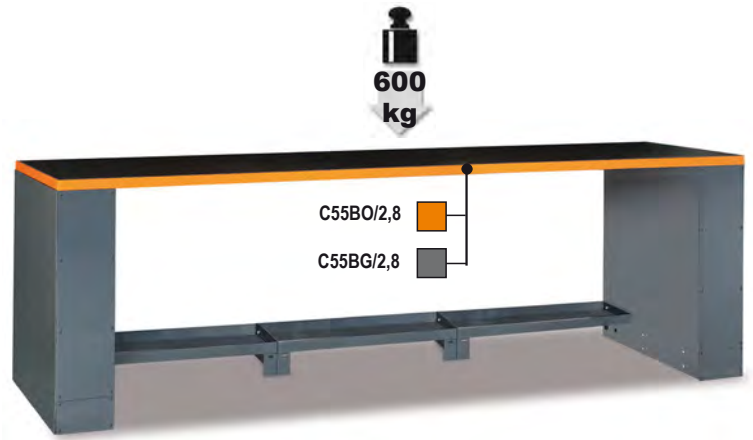

C55BO/2,8

C55BG/2,8

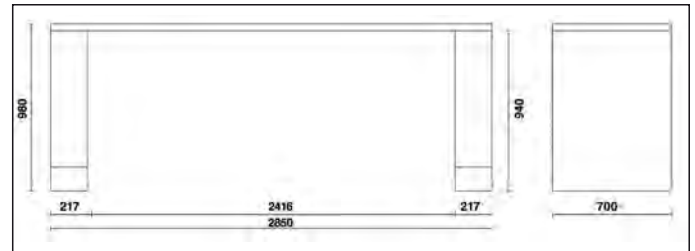

C55BO/2,8	1	055000261
C55BG/2,8	1	055000281

C55PRO B/2,8

2.8-m-long workbench, for workshop equipment combination

With worktop (2850x700 mm) covered with a shockproof, non-scratch PVC coat, resistant to hydrocarbons

Built-in sockets and hose reel:

- Schuko socket +16+10A
- EU Plug 10A
- Compressed air outlet with hose reel, Ø 8 mm, hose length: 10 m.
- Holes for a vice (1599F/150 - 1599GI/150, to be ordered separately)
- Vertically adjustable feet

134 kg

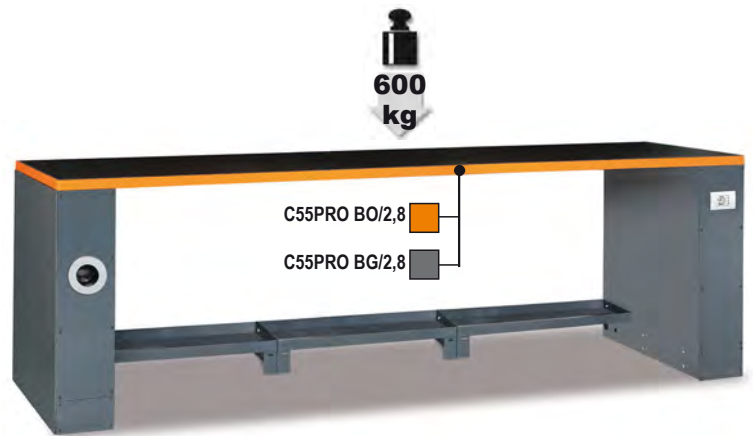

C55PRO BO/2,8

C55PRO BG/2,8

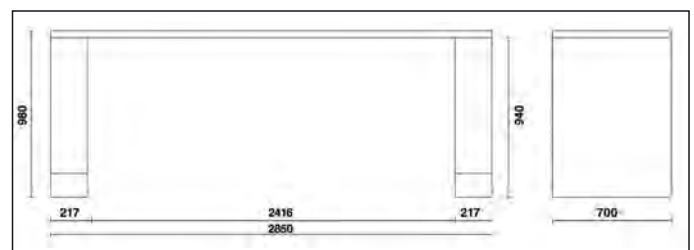

C55PRO BO/2,8	1	055000271
C55PRO BG/2,8	1	055000283

C55B-D4

double 4-m-long workbench with central leg

Worktop (4100x700 mm) covered with a shockproof, non-scratch PVC coat, resistant to hydrocarbons

- Holes for a vice 1599F/150 - 1599GI/150 (to be ordered separately)
- Vertically adjustable feet
- Double central leg with compartment and slide-away door, 350x750 mm

185 kg

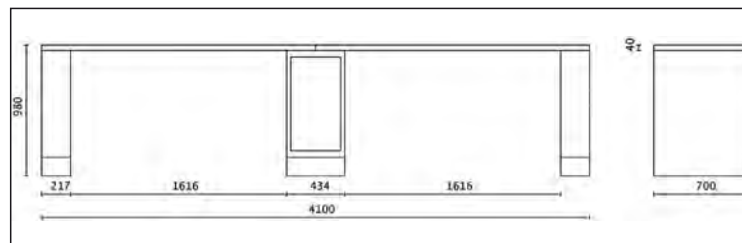
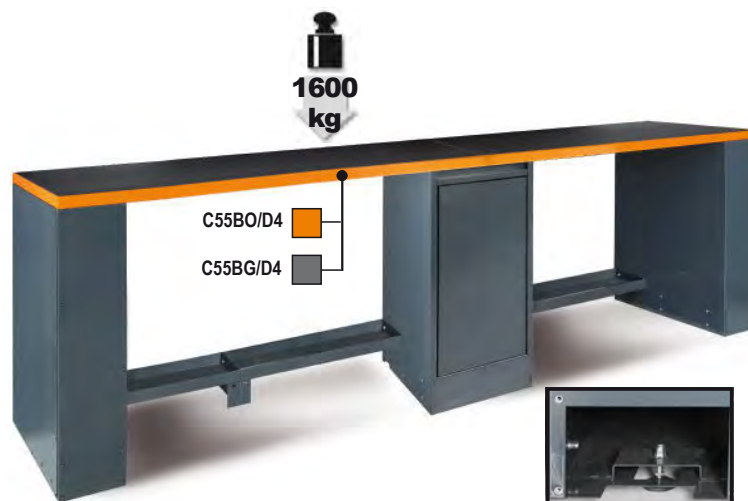

C55BO/D4	1	055000109
C55BG/D4	1	055000119

C55PRO B-D4

double 4-m long workbench with central leg

With worktop (4100x700 mm) covered with a shockproof, non-scratch PVC coat, resistant to hydrocarbons

Built-in sockets and cable reel:

- Schuko socket +16+10A
- EU Plug 10A
- Compressed air outlet with hose reel, Ø 8 mm, cable length: 10 m.
- Holes for a vice (1599F/150 - 1599GI/150, to be ordered separately)
- Vertically adjustable feet
- Double central leg with tool compartment and door, 365x750 mm

190 kg

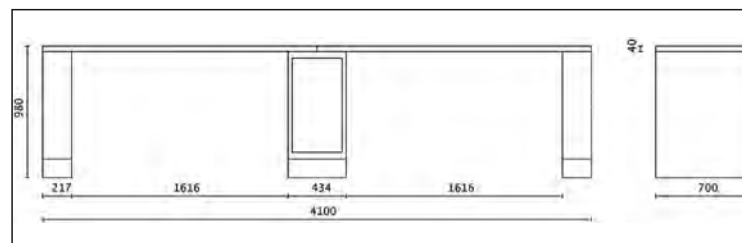
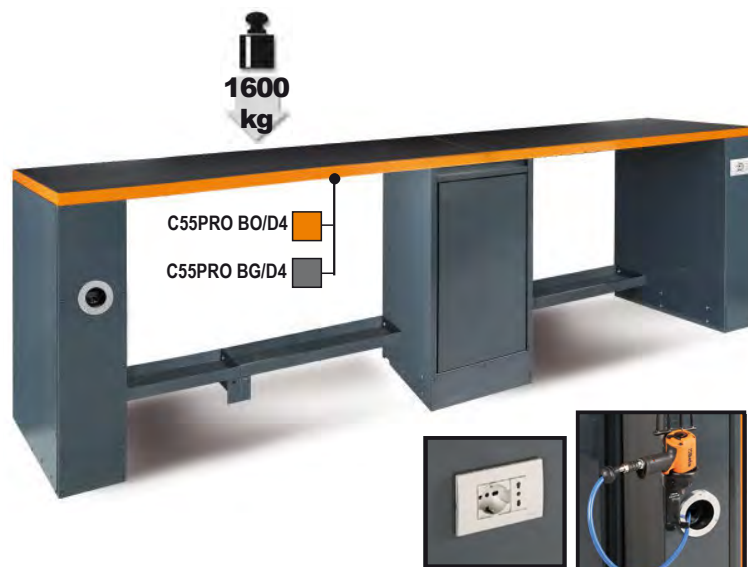

C55PRO-BO/D4	1	055000159
C55PRO-BG/D4	1	055000179

Beta

C55B/G

universal leg for workshop equipment workbench

- With vertically adjustable feet

32 kg

C55B/G

1 055000096

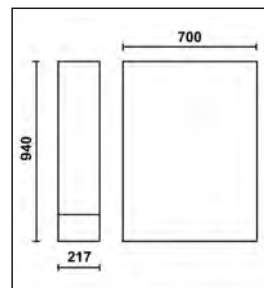

C55B/GAA

universal leg for workbench with built-in hose reel

- Built-in automatic hose reel for compressed air or cold water, Ø 8 mm
- Hose length: 10 m 1900S 8x10
- With vertically adjustable feet
- Front and side access

36,4 kg

C55B/GAA

1 055000099

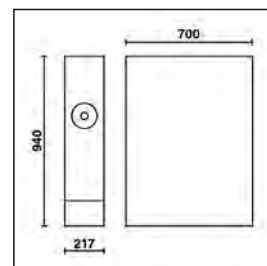

C55B/GDP

double leg for adjoining workshop equipment workbenches

- Paper roll holder compartment
- Compartment with door
- With vertically adjustable feet

45 kg

C55B/GDP

1 055000292

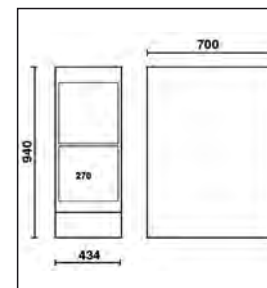

C55B/GDS

double leg for adjoining workshop equipment workbenches

- Compartment with slide-away door, 365x750 mm
- With vertically adjustable feet

45 kg

C55B/GDS

1 055000291

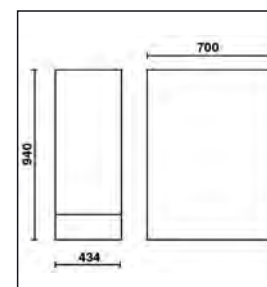

C55B/GE

universal leg with power sockets for workshop equipment workbench

- Schuko socket+16+10A
- EU Plug +10A
- With vertically adjustable feet

30,4 kg

C55B/GE

1 055000097

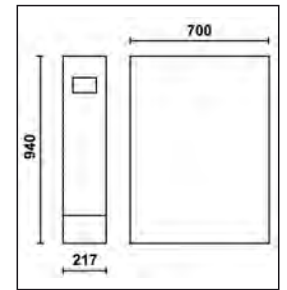

C55B/GAE

universal leg with built-in electrical cable reel for workbench, for workshop equipment combination

- Built-in automatic cable reel with Schuko type socket 1844 15H05SCK
- Cable length: 15 m
- With thermal protection switch
- With vertically adjustable feet
- Front and side access

37,5 kg

C55B/GAE

1 055000094

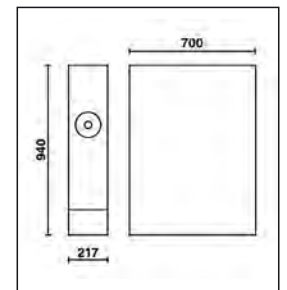
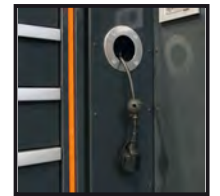

Beta

C55/PL-1,024

1-m-long worktop for workbench extension

Painted sheet metal worktop (1024x700 mm) covered with a shockproof, non-scratch PVC coat, resistant to hydrocarbons

21 kg

C55/PLO-1,024	1	055000130
C55/PLG-1,024	1	055000131



C55B PT/2

2-m-long worktop for workbench, for workshop equipment combination

Painted sheet metal worktop (2050x700 mm) covered with a shockproof, non-scratch PVC coat, resistant to hydrocarbons
Holes for a vice (1599P/150 - 1599GI/150, to be ordered separately)

43 kg

C55BO PT/2	1	055000106
C55BG PT/2	1	055000116



C55B PT/2,8

2.8-m-long worktop for workbench, for workshop equipment combination

Painted sheet metal worktop (2850x700 mm) covered with a shockproof, non-scratch PVC coat, resistant to hydrocarbons
Holes for a vice (1599P/150 - 1599GI/150, to be ordered separately)

67 kg

C55BO PT/2,8	1	055000266
C55BG PT/2,8	1	055000286



C55RB

shockproof, non-scratch PVC coat, resistant to hydrocarbons

For protecting worktop.

C55RB/2: for 2-m-long worktop

C55RB/2.8: for 2.8-m-long worktop

C55RB/0.7: for 700x700mm worktop

C55RB/1: for 1-m-long worktop

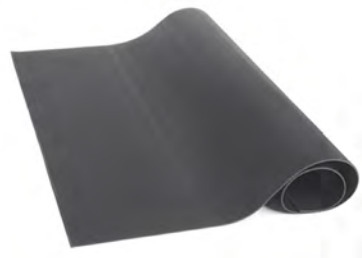

C55RB/2	1	055000195
C55RB/2,8	1	055000196
C55RB/0,7	1	055000199
C55RB/1	1	055000198

C55B/VS

lower workbench bracket, 0.8 m long

Dimensions: 800x230x60 mm

4,2 kg

C55B/VS	1	055000095
---------	---	-----------

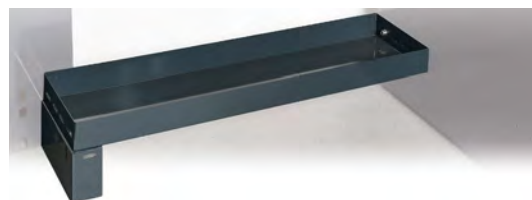

C55C7

mobile roller cab with seven drawers, for workshop equipment combination

- 7 drawers (588x367 mm), with ball bearing slides
- 4 castors Ø 100 mm, 2 fixed (one with brake) and 2 steering
- Aluminium opening system throughout length of drawer
- Drawer bases protected by foamed rubber mats
- Front centralized lock
- Can be fitted with foam trays

79 kg

1000 kg



h	max
70 mm	30 kg
245 mm	40 kg

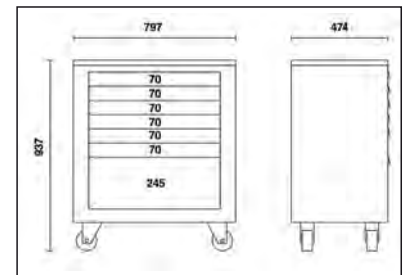
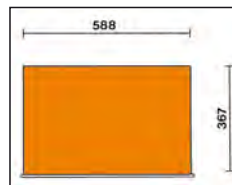

C55C7

1 055000201

Beta



C55C8

roller cab module with eight drawers, for workshop equipment combination

- 8 drawers(588x367 mm) with ball bearing slides
- 4 castors Ø 100 mm, 2 fixed (one with brake) and 2 steering
- Aluminium opening system throughout length of drawer
- Drawer bases protected by foamed rubber mats
- Front centralized lock
- Can be fitted with foam trays

80,8 kg



h	max
70 mm	30 kg
175 mm	40 kg

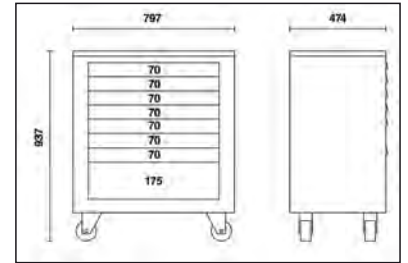
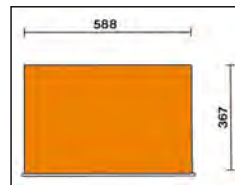

C55C8

1 055000206

C55M2

fixed module with 2 drawers, for workshop equipment combination

- 2 drawers (588x367mm) with ball bearing slides
- Aluminium opening system throughout length of drawer
- Drawer bases protected by foamed rubber mats
- Front centralized lock

66 kg



h	max
280 mm	40 kg
385 mm	40 kg

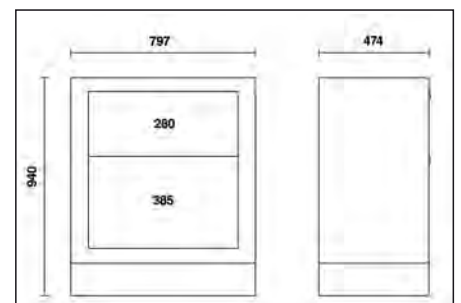
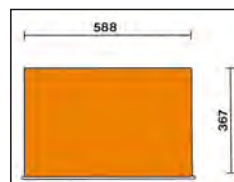

C55M2

1 055000202

C55M4

fixed module with 4 drawers, for workshop equipment combination

4 drawers (588x367 mm) with ball bearing slides

- Aluminium opening system throughout length of drawer
- Drawer bases protected by foamed rubber mats
- Front centralized lock

75 kg

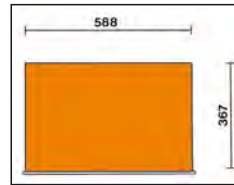

h	max
140 mm	30 kg
245 mm	40 kg

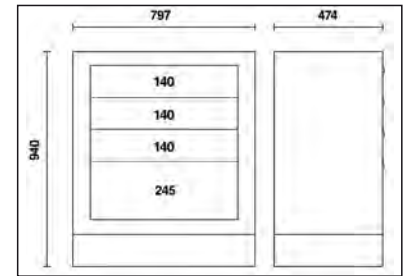

C55M4

1 055000212

C55M7

fixed module with seven drawers, for workshop equipment combination

7 drawers (588x367 mm) with ball bearing slides

- Aluminium opening system throughout length of drawer
- Drawer bases protected by foamed rubber mats
- Front centralized lock
- Can be fitted with foam trays

78 kg

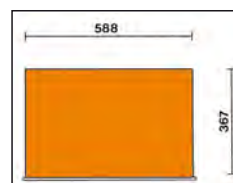

h	max
70 mm	30 kg
245 mm	40 kg

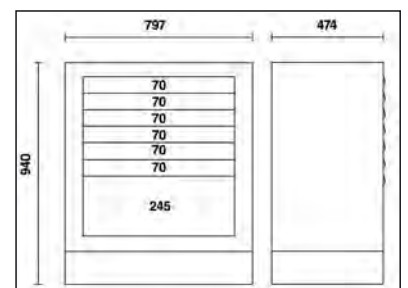

C55M7

1 055000203

C55M8

fixed module with 8 drawers for workshop equipment combination

8 drawers (588x367 mm) with ball bearing slides

- Aluminium opening system throughout length of drawer
- Drawer bases protected by foamed rubber mats
- Front centralized lock
- Can be fitted with foam trays

📦 78,9 kg



h	max
70 mm	30 kg
175 mm	40 kg

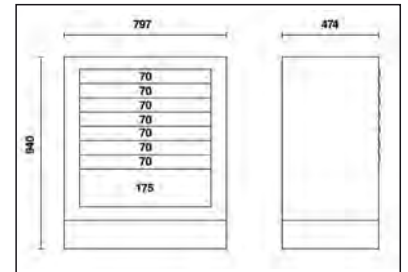
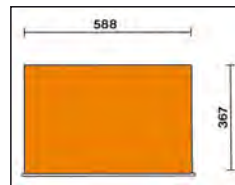

C55M8



1 055000207

C55CS

fixed sorted waste collection module for workshop equipment combination

- Pull-out waste compartment (588x465) with ball bearing slides
- 2 capacious pull-out interior containers for sorting waste

📦 61,4 kg

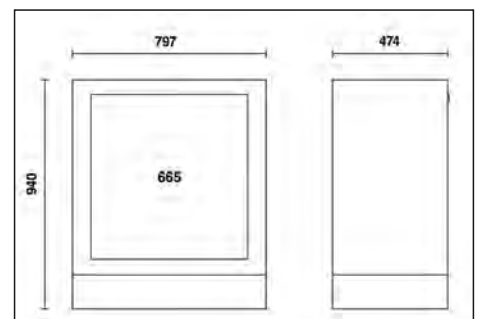

C55 CS



1 055000208

C55MA

fixed two-door module, for workshop equipment combination

- Push Pull opening
- With lock • Interior shelf, vertically adjustable

75 kg

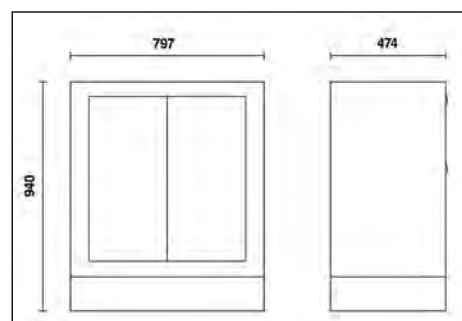

C55MA

1 055000205

C55MDO

fixed oil distribution module
for workshop equipment combination

- 2 reels with 7m - 1/2" hose included
- Complete with 2 guns with digital litre counter and automatic drip catcher.
- max. flow rate: 30 l/min
- viscosity: 8÷2000 mPas

93,4 kg

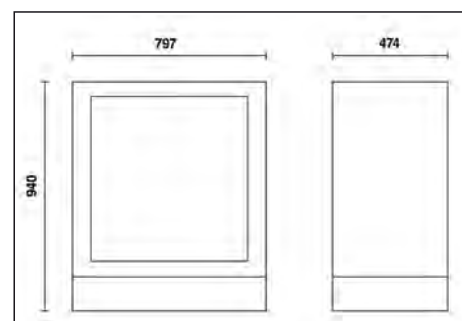

C55MDO

1 055000210

C55MS

fixed service module, for workshop equipment combination

- Built-in waste bin
- Perforated paper roll compartment
- Storage drawer, 305x270 mm

75 kg

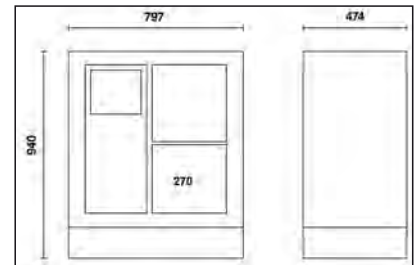

C55MS

1 055000204

C55T3

trolley

- 3 tops covered in antislip ribbed rubber
- Ergonomic handle
- Two fixing options for central worktop
- Four castors Ø 100 mm (two with brakes)
- Static load capacity: 200 kg (distributed between 3 shelves)

22,8 kg

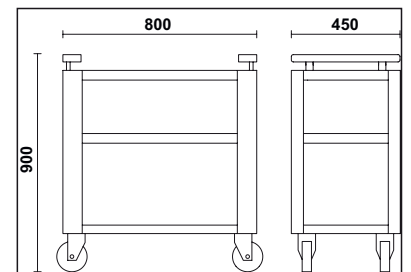

C55T3

1 055000219

C55P/MCD

double central intermediate uprights

10 kg

C55P/MCD

1 055000257



C55P/2MDX-SX

right/left wall uprights, pair

10 kg

C55P/2MDX-SX

1 055000253



C55PM

suspended cabinet for workshop equipment combination, 1 m long

• Dimensions: 1024x400x300 mm; fitted with gas springs, making it easier to open and close door

23,4 kg

C55PM

1 055000302

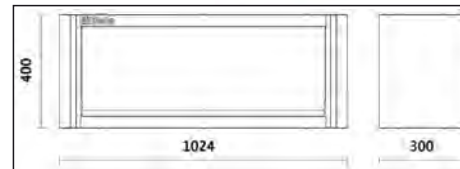

C55PFA-1,0

self-supporting perforated panel, 1 m long, for workshop equipment combination

Perforated steel tool panel (1024x1020x25 mm)

11 kg

C55PFA-1,0

1 055000316

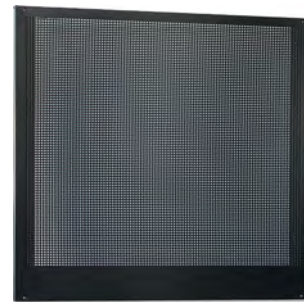

C55/PF

perforated under-cabinet panel for workshop equipment combination, 1 m long

• Perforated tool panel (1024x600 mm)

6 kg

C55/PF

1 055000307



C55PT1,0X0,6

under-cabinet panel, 1 m long

Dimensions: 1024x620x25 mm

8 kg

C55PT1,0X0,6

1 055000314



C55PTE-1,0

under-cabinet panel, 1 m long

Dimensions: 1024x620x25 mm

Accommodates 2 power sockets (not included)

8 kg

C55PTE-1,0

1 055000319



C55/2PM

tool wall system with 2 suspended cabinets, for workshop equipment combination

- 2 suspended cabinets, 1024x400x300 mm, fitted with gas springs, making it easier to open and close doors.
- Wall panel, 2050x620 mm; can accommodate perforated tool panels C55/PF (to be ordered separately)
- Supplied with framework
- Matches 2-m-long workbench

82,7 kg

C55/2PM

1 055000301

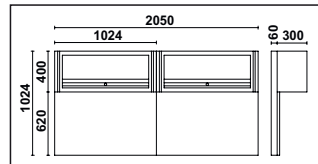
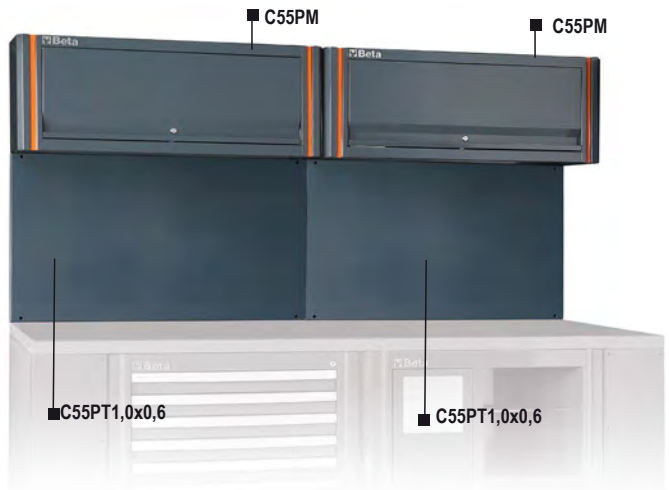

C55PFA-0,8

self-supporting perforated panel, 0.8 m long, for workshop equipment combination

Perforated steel tool panel (800x1020x25 mm)

10 kg

C55PFA-0,8

1 055000315

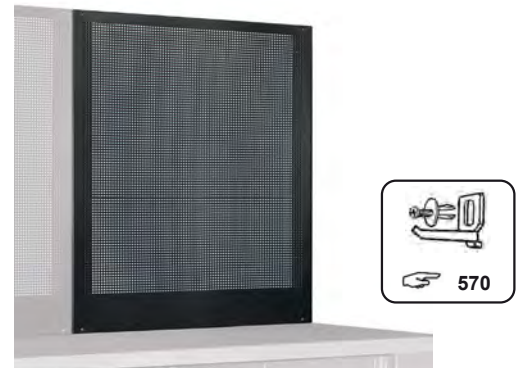

C55PM/M0,8

suspended cupboard, 0.8 m long, for workshop equipment combination

Dimensions: 800x400x300 mm; fitted with gas springs making it easier to open and close door

19 kg

C55PM/M0,8

1 055000312



C55PTE-0,8

under-cabinet panel, 0.8 m long

Dimensions: 800x620x25 mm

Accommodates 1 power socket (not included)

6 kg

C55PTE-0,8

1 055000318



C55PT0,8X0,6

under-cabinet panel, 0.8 m long

Dimensions: 800x620x25 mm

7,8 kg

C55PT0,8X0,6

1 055000313



C55/1PF

perforated tool panel, for workshop equipment combination

• Perforated tool panel (800x600 mm)

4,6 kg

C55/1PF

1 055000309



C55PS

tool wall system with shutter, for workshop equipment combination

- Aluminium shutter, vertically adjustable, with lock
- Removable perforated tool panel
- Supplied with framework
- 50-hook GPS kit included
- Matches 2-m-long workbench

85,7 kg

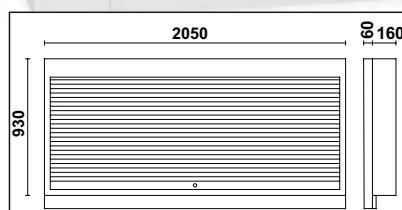

C55PS-O	1	055000250
C55PS-G	1	055000255

C55PSE

tool wall system with shutter
accommodating 2 power sockets

- Aluminium shutter, vertically adjustable, with lock
- Removable perforated tool panel
- Supplied with framework
- 50-hook GPS kit included
- Accommodates power sockets
- Matches 2-m-long workbench

85,7 kg

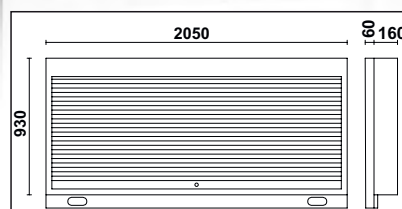

C55PSE-O	1	055000258
C55PSE-G	1	055000260

C55AE

profile, 2 m long, accommodating power sockets

Dimensions: 2050x25x90mm
Accommodates 2 power sockets

3 kg



C55AE	1	055000325
-------	---	-----------

C55AC

self-supporting complete corner

Worktop (700x700 mm) with legs
2 upper tool wall systems complete with 2 fixing shelves (665x150 mm)

63 kg

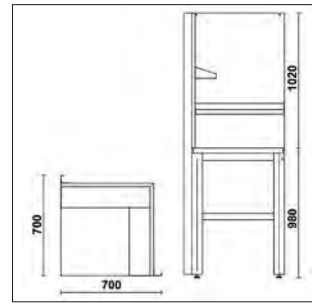

C55AC-O
C55AC-G

C55AC-O	1	055000360
C55AC-G	1	055000380

C55KAI

corner worktop for workshop equipment combination

• Painted sheet metal worktop (700x700 mm) covered with a shockproof, non-scratch PVC coat, resistant to hydrocarbons

33 kg



C55KAI-O
C55KAI-G

C55KAI-O	1	055000365
C55KAI-G	1	055000385

C55MP

steel corner wall shelves

Dimensions: 700x160x80 mm

3 kg



C55MP	1	055000374
-------	---	-----------

Beta

C55A1

sheet metal single-door tool cabinet, for workshop equipment combination

- 3 removable, vertically adjustable shelves
- convenient folding clothes rail under first shelf
- with lock
- usable interior dimensions: 1770x420x420 mm

47,3 kg

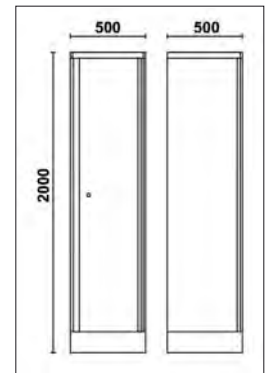

C55A1

1 055000411

C55A1/R42

interior shelf for tool cabinet C55A1/C55AT1

1,9 kg



C55A1/R42

497x403 mm

1 055000461

C55 A1/RB42

interior shelf for tool cabinet C55A1/C55AT1, with clothes rail

2,3 kg

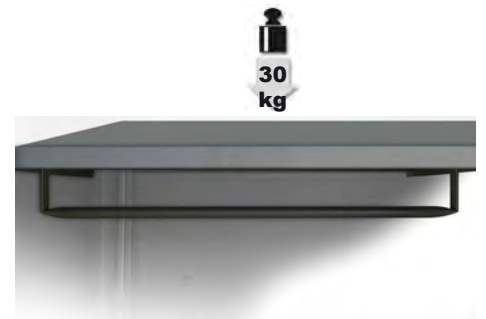

C55 A1/RB42

mm
497x403

1 055000463



C55A2

sheet metal two-door tool cabinet, for workshop equipment combination

- 3 removable, vertically adjustable shelves
- With lock
- Usable interior dimensions: 1798x797x403 mm

69,5 kg

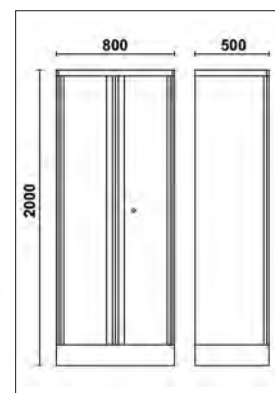

C55A2

1 055000412

C55A2/R70

interior shelf for tool cabinet C55A2/C55AT2

3,6 kg

50 kg

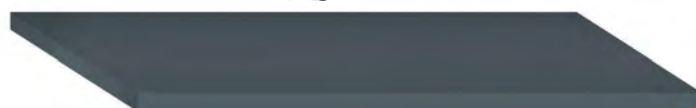

C55A2/R70

700x420 mm

1 055000462

Beta

C55AT1

sheet metal tool cabinet with clear polycarbonate door, for workshop equipment combination

- 3 removable, vertically adjustable shelves
- With lock
- Usable interior dimensions: 1798x497x403 mm

41 kg

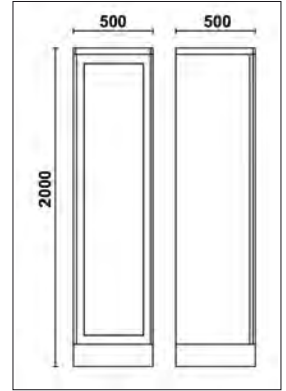

C55AT1

1 055000421

C55AT2

sheet metal tool cabinet with two clear polycarbonate doors, for workshop equipment combination

- 3 removable, vertically adjustable shelves
- With lock
- Usable interior dimensions: 1798x797x403 mm

56 kg

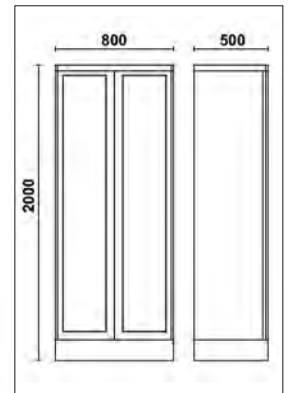

C55AT2

1 055000422

C55STR

adhesive tape 25 m

allows to tailor the vertical tapes of garage furniture item C55



RAL2011
RAL3000
RAL6029
RAL9016
RAL1023
RAL5015
RAL1035
RAL9006

C55STR-O/2011	Orange	1	055000901
C55STR-R/3000	Red	1	055000903
C55STR-V/6029	Green	1	055000906
C55STR-Y/1023	Yellow	1	055000905
C55STR-B/5015	Blue	1	055000904
C55STR-S/9006	Grey	1	055000902





WORKSHOP EQUIPMENT RSC50 2.0



Beta keeps evolving in line with market trends, to successfully take up the challenges of the future.

As a result, the workshop equipment combination, RSC50, has been upgraded into **the new, revolutionary system, RSC50 2.0**. The new **70-cm-long worktop**, the three types of material to choose from (sheet metal, **multi-ply wood** and **stainless steel coated MDF**) make RSC50 2.0 a one-of-a-kind ITALIAN-MADE line.

RSC50 2.0 means a perfect combination of modern design and unparalleled functionality. Designed to satisfy today's professionals' requirements.



QUALITY

Our acclaimed care in choosing the materials, painstaking attention for detail and, last but not least, the captivating design make the RSC50 2.0 a one-of-a-kind workshop equipment range.



FUNCTIONALITY AND STURDINESS

The **70-cm-deep worktop** means having a large, convenient, functional work surface available. It can be fitted with a vice, thereby allowing heavy-duty jobs to be carried out.



EFFICIENCY

Simple, quick installation, based on the optimized production of the various parts of the range.



FLEXIBILITY

Each workshop equipment combination can be extended or modified at any time as required. **You can choose the material of your worktop:** sheet metal, multi-ply wood or stainless steel coated MDF.



COMPATIBILITY

The drawers in Beta's standard dimensions (588x367 mm) can accommodate the numerous tool modules, which are available in both soft and hard versions, made from EVA and ABS respectively.

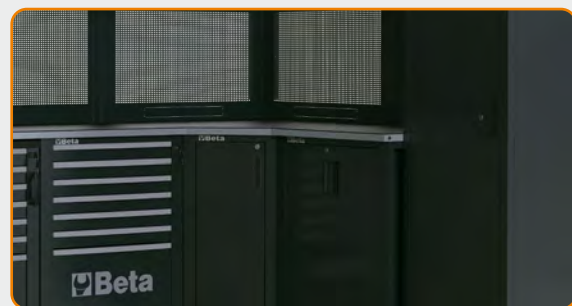
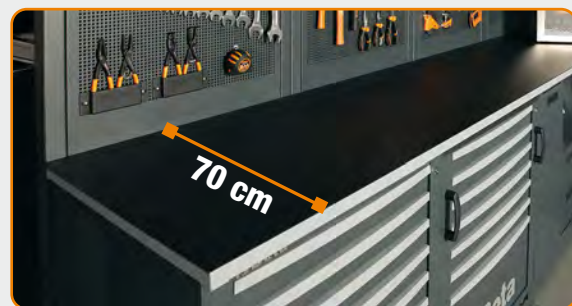



WORKSHOP EQUIPMENT RSC50 2.0



Configure your workshop
in 3D online on
www.beta-tools.com/rsc50

The new workshop equipment range, RSC50 2.0, comprises preassembled combinations, developed by Beta for professionals; alternatively, you can design your workplace on your own, choosing from many under-bench modules, wall-mounted cabinets and furnishing accessories.

The workshop equipment range, RSC50 2.0, comprises preassembled combinations, developed by Beta for professionals; alternatively, you can design your workplace on your own, choosing from many under-bench modules, wall-mounted cabinets and furnishing accessories.

RSC50 2.0 I

workshop equipment combination RSC50 2.0

Combination comprising the following:

- 1 worktop, 2,240x700 mm (RSC50 2.0 NPG/3-2.2MT)
- 1 worktop, 1,495x700 mm (RSC50 2.0 NPG/2-1,5MT)
- 1 fixed module with 7 drawers (RSC50 2.0 M7)
- 1 mobile roller cab with 7 drawers (RSC50 2.0 C7)
- 1 fixed service module with 2 drawers (RSC50 2.0 MS-2C)
- 1 self-supporting complete corner (RSC50 2.0 NAC-G)
- 1 fixed module with 5 drawers (RSC50 2.0 M5)
- 1 fixed two-door module (RSC50 2.0 MA)
- 5 wall-mounted cabinets (RSC50 2.0 PM)
- 5 upper perforated tool panels (RSC50 2.0 PFS)
- 5 lower perforated tool panels (RSC50 2.0 PFI)
- 5 pairs of right/left uprights (RSC50 2.0 P/2MDX-SX)
- 2 single-door cabinets (RSC50 2.0 A1)

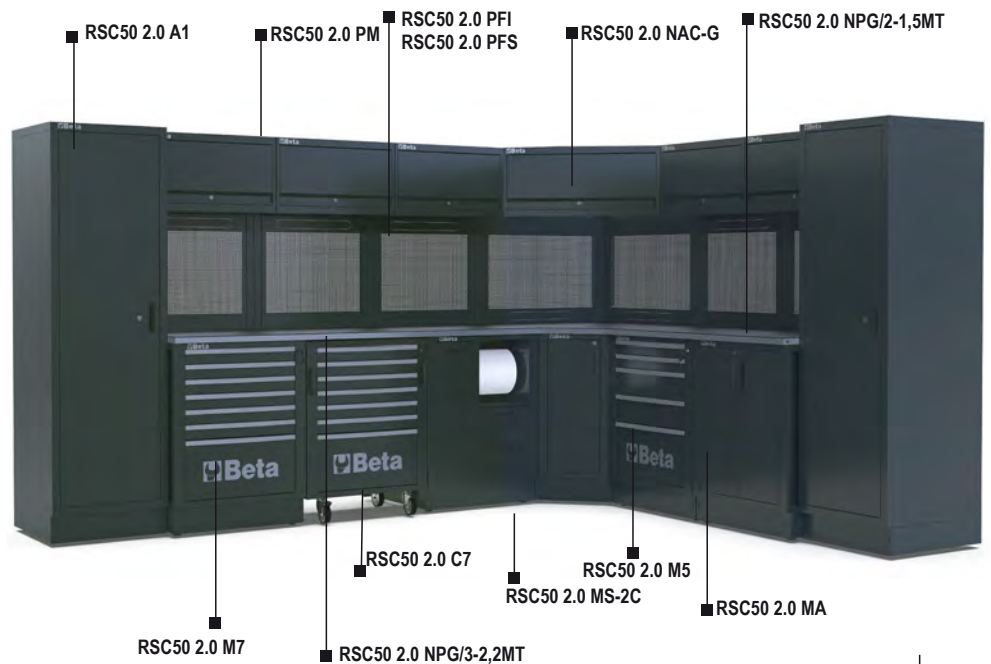

804 kg

RSC50 2.0 I

1 050001046

RSC50 2.0 L

workshop equipment combination RSC50 2.0

Combination comprising the following:

- 1 worktop, 2,240x700 mm (RSC50 2.0 NPG/3-2.2MT)
- 1 worktop, 750x700 mm (RSC50 2.0 NPG/1-0.7MT)
- 1 fixed service module (RSC50 2.0 MS-2AVV) with compressed air hose reel item 1900S 8x10 and cable reel item 1844 15-H05/SCK (included)
- 1 mobile roller cab with 7 drawers (RSC50 2.0 C7)
- 1 fixed module with 7 drawers (RSC50 2.0 M7)
- 1 self-supporting complete corner (RSC50 2.0 NAC-G)
- 1 fixed two-door module (RSC50 2.0 MA)
- 1 tool wall system with aluminium shutter and framework (RSC50 2.0 PS)
- 2 wall-mounted cabinets (RSC50 2.0 PM)
- 2 upper perforated tool panels (RSC50 2.0 PFS)
- 2 lower perforated tool panels (RSC50 2.0 PFI)
- 2 pairs of right/left uprights (RSC50 2.0 P/2MDX-SX)
- 2 single-door cabinets (RSC50 2.0 A1)

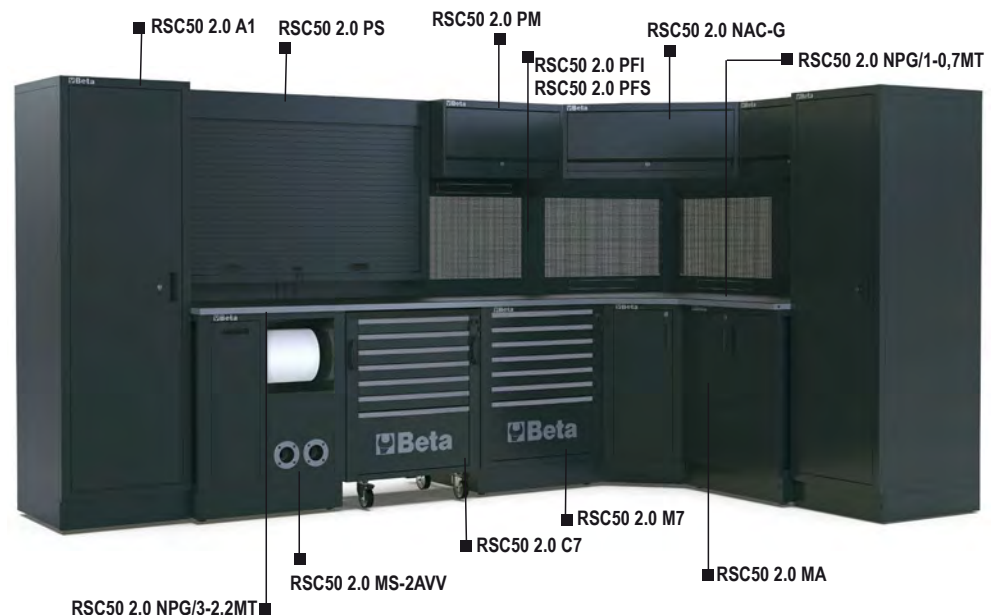

720 kg

RSC50 2.0 L

1 050001051

RSC50 2.0

workshop equipment combination RSC50 2.0

Combination comprising the following:

- 1 single-door cabinet (RSC50 2.0 A1)
- 1 worktop, 750x700 mm (RSC50 2.0 NPG/1-0.7MT)
- 1 worktop, 2,240x700 mm (RSC50 2.0 NPG/3-2.2MT)
- 1 mobile roller cab with 7 drawers (RSC50 2.0 C7)
- 1 fixed module with 4 drawers (RSC50 2.0 M4)
- 1 fixed module with 7 drawers (RSC50 2.0 M7)
- 1 fixed service module (RSC50 2.0 MS-AVV) with compressed air hose reel item 1900S 8x10 (included)
- 1 tool wall system with aluminium shutter and framework (RSC50 2.0 PS)
- 2 wall-mounted cabinets (RSC50 2.0 PM)
- 2 upper perforated tool panels (RSC50 2.0 PFS)
- 2 lower perforated tool panels (RSC50 2.0 PFI)
- 2 pairs of right/left uprights (RSC50 2.0 P/2MDX-SX)
- 1 two-door cabinet (RSC50 2.0 A2)

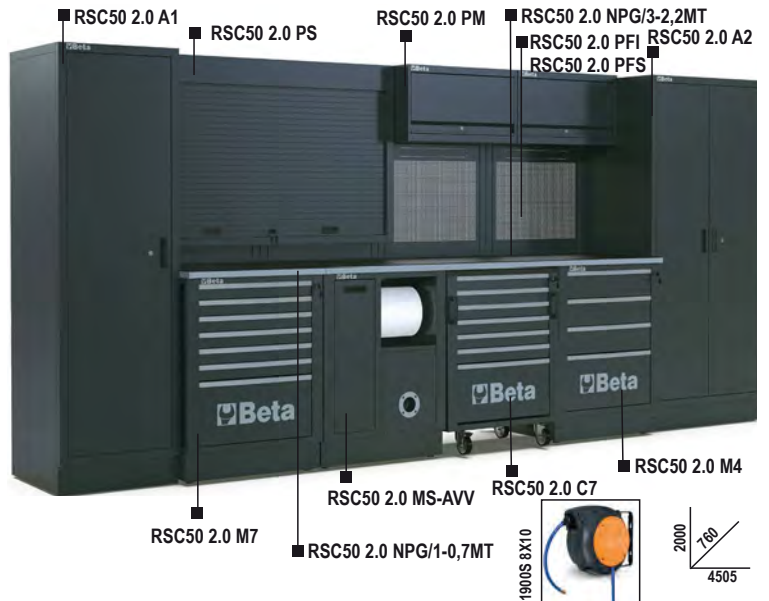

604 kg

RSC50 2.0



050001001

RSC50 2.0 H

workshop equipment combination RSC50 2.0

Combination comprising the following:

- 1 worktop, 2,240x700 mm (RSC50 2.0 NPG/3-2,2MT)
- 1 fixed service module with 2 drawers (RSC50 2.0 MS-2C)
- 1 mobile roller cab with 7 drawers (RSC50 2.0 C7)
- 1 fixed module with 7 drawers (RSC50 2.0 M7)
- 1 fixed module with built-in sink (RSC50 2.0 ML)
- 4 wall-mounted cabinets (RSC50 2.0 PM)
- 4 upper perforated tool panels (RSC50 2.0 PFS)
- 4 lower perforated tool panels (RSC50 2.0 PFI)
- 4 pairs of right/left uprights (RSC50 2.0 P/2MDX-SX)
- 1 single-door cabinet (RSC50 2.0 A1)

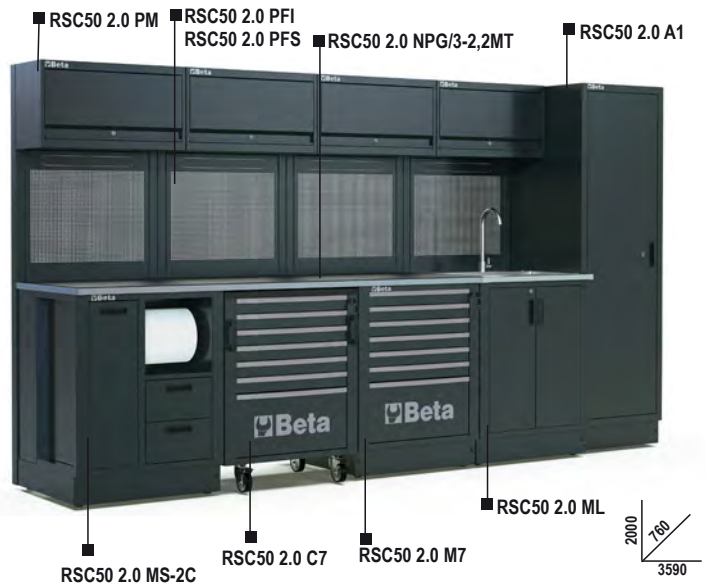

464 kg

RSC50 2.0 H



050001041

RSC50 2.0 G

workshop equipment combination RSC50 2.0

Combination comprising the following:

- 1 worktop, 2,240x700 mm (RSC50 2.0 NPG/3-2.2MT)
- 1 fixed service module (RSC50 2.0 MS-2AVV) with compressed air hose reel item 1900S 8x10 and cable reel item 1844 15-H05/SCK (included)
- 1 mobile roller cab with 7 drawers (RSC50 2.0 C7)
- 1 fixed module with 4 drawers (RSC50 2.0 M4)
- 3 wall-mounted cabinets (RSC50 2.0 PM)
- 3 upper perforated tool panels (RSC50 2.0 PFS)
- 3 lower perforated tool panels (RSC50 2.0 PFI)
- 3 pairs of right/left uprights (RSC50 2.0 P/2MDX-SX)
- 1 two-door cabinet (RSC50 2.0 A2)

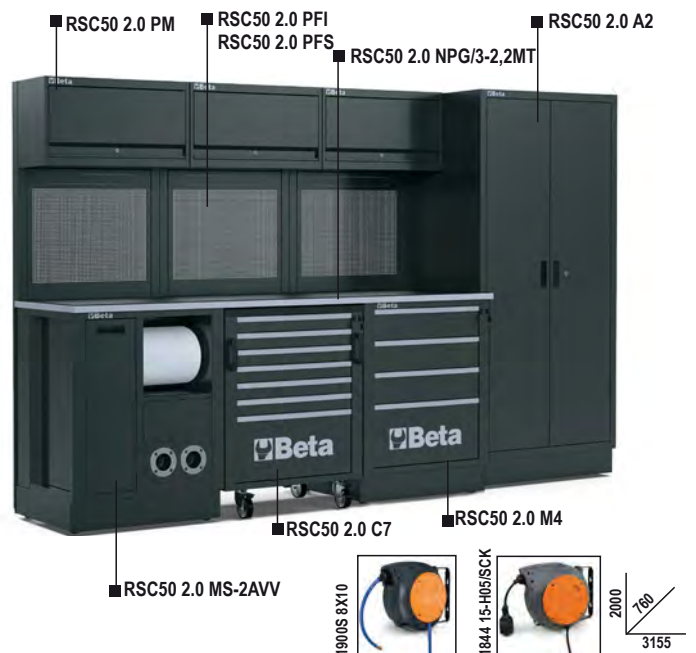

416 kg

RSC50 2.0 G



050001036

RSC50 2.0 F

workshop equipment combination RSC50 2.0

Combination comprising the following:

- 1 worktop, 2,240x700 mm (RSC50 2.0 NPG/3-2.2MT)
- 1 fixed module with 7 drawers (RSC50 2.0 M7)
- 1 mobile roller cab with 7 drawers (RSC50 2.0 C7)
- 1 fixed service module with 2 drawers (RSC50 2.0 MS-2C)
- 3 wall-mounted cabinets (RSC50 2.0 PM)
- 3 upper perforated tool panels (RSC50 2.0 PFS)
- 3 lower perforated tool panels (RSC50 2.0 PFI)
- 3 pairs of right/left uprights (RSC50 2.0 P/2MDX-SX)
- 1 two-door cabinet (RSC50 2.0 A2)

411 kg

RSC50 2.0 F

1 050001031

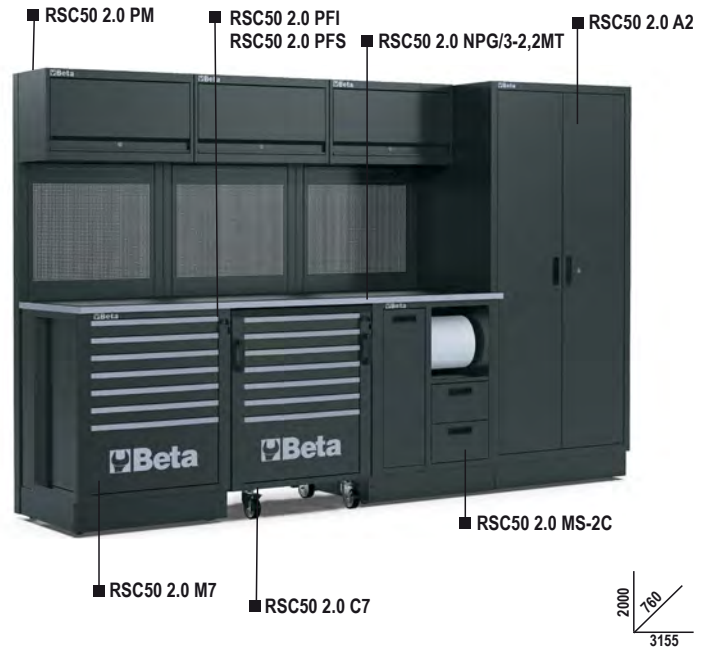

RSC50 2.0 FX

workshop equipment combination RSC50 2.0

Combination comprising the following:

- 1 worktop (2,240x700 mm) made from stainless steel coated MDF (RSC50 2.0 PX/3-2.2MT)
- 1 fixed module with 7 drawers (RSC50 2.0 M7)
- 1 mobile roller cab with 7 drawers (RSC50 2.0 C7)
- 1 fixed service module with 2 drawers (RSC50 2.0 MS-2C)
- 3 wall-mounted cabinets (RSC50 2.0 PM)
- 3 upper perforated tool panels (RSC50 2.0 PFS)
- 3 lower perforated tool panels (RSC50 2.0 PFI)
- 3 pairs of right/left uprights (RSC50 2.0 P/2MDX-SX)
- 1 two-door tool cabinet (RSC50 2.0 A2)

405 kg

RSC50 2.0 FX

1 050001032



RSC50 2.0 FW

workshop equipment combination RSC50 2.0

Combination comprising the following:

- 1 worktop (2,240x700 mm) made from multi-ply wood (RSC50 2.0 PW/3-2.2MT)
- 1 fixed module with 7 drawers (RSC50 2.0 M7)
- 1 mobile roller cab with 7 drawers (RSC50 2.0 C7)
- 1 fixed service module with 2 drawers (RSC50 2.0 MS-2C)
- 3 wall-mounted cabinets (RSC50 2.0 PM)
- 3 upper perforated tool panels (RSC50 2.0 PFS)
- 3 lower perforated tool panels (RSC50 2.0 PFI)
- 3 pairs of right/left uprights (RSC50 2.0 P/2MDX-SX)
- 1 two-door tool cabinet (RSC50 2.0 A2)

386 kg

RSC50 2.0 FW

1 050001033

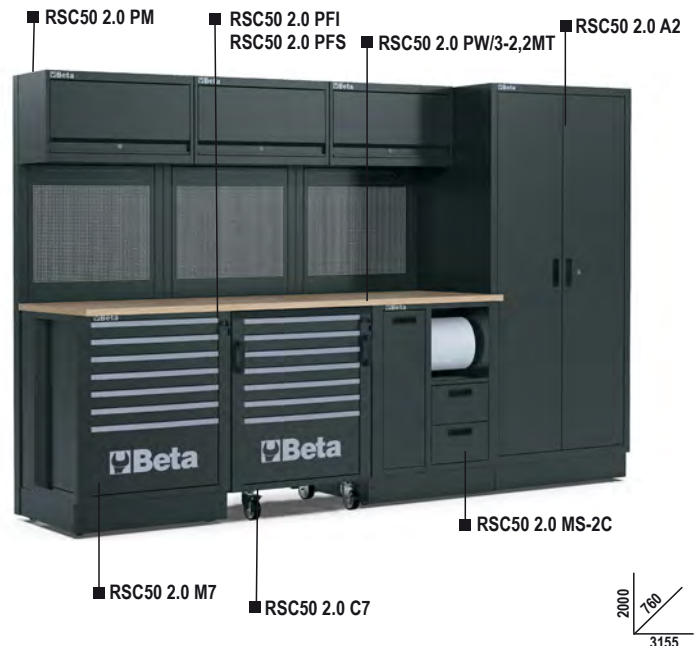

RSC50 2.0 E

workshop equipment combination RSC50 2.0

Combination comprising the following:

- 1 worktop, 2,240x700 mm (RSC50 2.0 NPG/3-2.2MT)
- 1 fixed service module with 2 drawers (RSC50 2.0 MS-2C)
- 1 fixed module with 7 drawers (RSC50 2.0 M7)
- 1 fixed two-door module (RSC50 2.0 MA)
- 3 wall-mounted cabinets (RSC50 2.0 PM)
- 3 upper perforated tool panels (RSC50 2.0 PFS)
- 3 lower perforated tool panels (RSC50 2.0 PFI)
- 3 pairs of right/left uprights (RSC50 2.0 P/2MDX-SX)

310 kg

RSC50 2.0 E

1 050001026



RSC50 2.0 D

workshop equipment combination RSC50 2.0

Combination comprising the following:

- 1 worktop, 1,495x700 mm (RSC50 2.0 NPG/2-1.5MT)
- 1 fixed module with 5 drawers (RSC50 2.0 M5)
- 1 fixed two-door module (RSC50 2.0 MA)
- 2 wall-mounted cabinets (RSC50 2.0 PM)
- 2 upper perforated tool panels (RSC50 2.0 PFS)
- 2 lower perforated tool panels (RSC50 2.0 PFI)
- 2 pairs of right/left uprights (RSC50 2.0 P/2MDX-SX)
- 1 single-door cabinet (RSC50 2.0 A1)

276 kg

RSC50 2.0 D

1 050001021

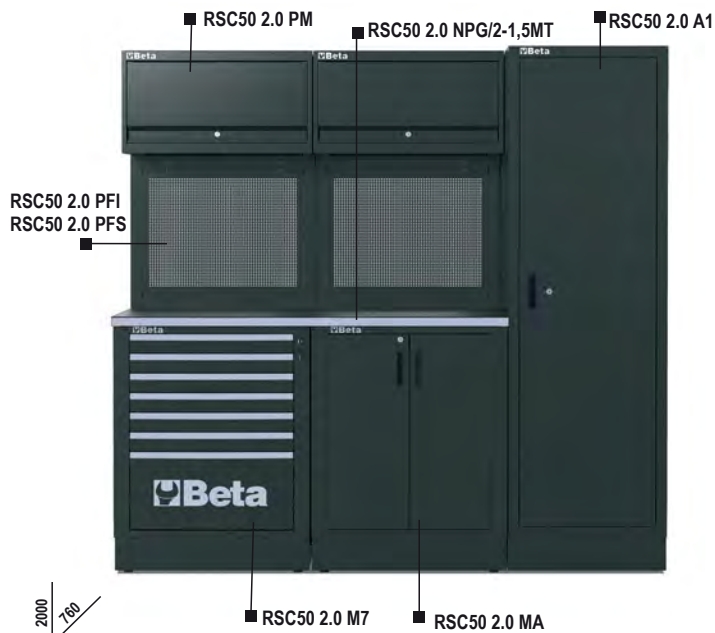

RSC50 2.0 DX

workshop equipment combination RSC50 2.0

Combination comprising the following:

- 1 worktop (1,495x700 mm) made from stainless steel coated MDF (RSC50 2.0 PX/2-1.5MT)
- 1 fixed module with 7 drawers (RSC50 2.0 M7)
- 1 fixed two-door module (RSC50 2.0 MA)
- 2 wall-mounted cabinets (RSC50 2.0 PM)
- 2 upper perforated tool panels (RSC50 2.0 PFS)
- 2 lower perforated tool panels (RSC50 2.0 PFI)
- 2 pairs of right/left uprights (RSC50 2.0 P/2MDX-SX)
- 1 one-door tool cabinet (RSC50 2.0 A1)

275 kg

RSC50 2.0 DX

1 050001023



RSC50 2.0 DW

workshop equipment combination RSC50 2.0

Combination comprising the following:

- 1 worktop (1,495x700 mm) made from multi-ply wood (RSC50 2.0 PW/2-1.5MT)
- 1 fixed module with 7 drawers (RSC50 2.0 M7)
- 1 fixed two-door module (RSC50 2.0 MA)
- 2 wall-mounted cabinets (RSC50 2.0 PM)
- 2 upper perforated tool panels (RSC50 2.0 PFS)
- 2 lower perforated tool panels (RSC50 2.0 PFI)
- 2 pairs of right/left uprights (RSC50 2.0 P/2MDX-SX)
- 1 one-door tool cabinet (RSC50 2.0 A1)

263 kg

RSC50 2.0 DW

1 050001024

2000
700
2095

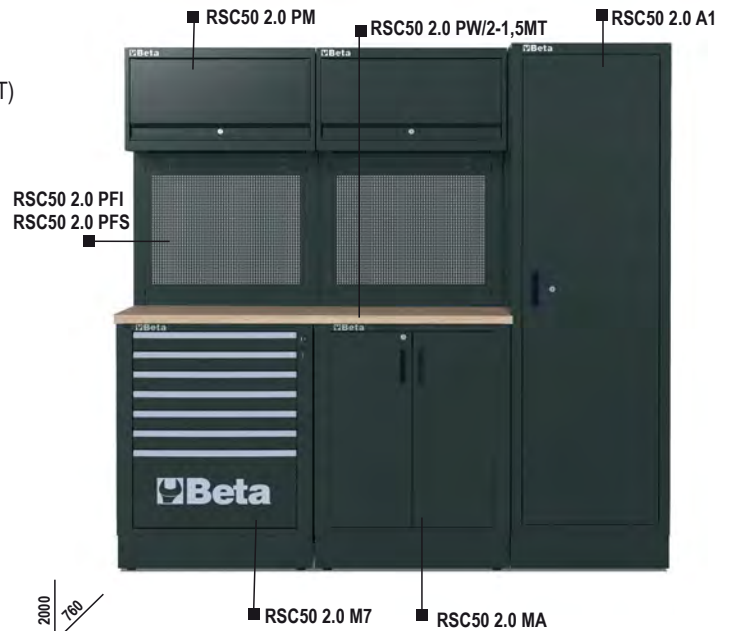

RSC50 2.0 C

workshop equipment combination RSC50 2.0

Combination comprising the following:

- 1 worktop, 1,495x700 mm (RSC50 2.0 NPG/2-1.5MT)
- 1 fixed service module with 2 drawers (RSC50 2.0 MS-2C)
- 1 fixed module with 7 drawers (RSC50 2.0 M7)
- 2 wall-mounted cabinets (RSC50 2.0 PM)
- 2 upper perforated tool panels (RSC50 2.0 PFS)
- 2 lower perforated tool panels (RSC50 2.0 PFI)
- 2 pairs of right/left uprights (RSC50 2.0 P/2MDX-SX)
- 1 single-door cabinet (RSC50 2.0 A1)

279 kg

RSC50 2.0 C

1 050001016

2000
700
2095

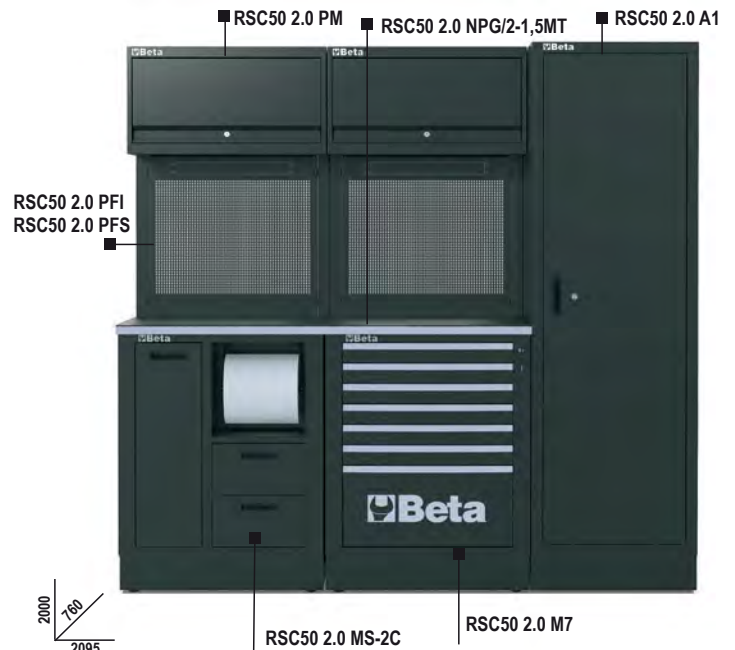

RSC50 2.0 B

workshop equipment combination RSC50 2.0

Combination comprising the following:

- 1 worktop, 1,495x700 mm (RSC50 2.0 NPG/2-1.5MT)
- 1 fixed two-door module (RSC50 2.0 MA)
- 1 fixed module with 7 drawers (RSC50 2.0 M7)
- 1 tool wall system with aluminium shutter and framework (RSC50 2.0 PS)

224 kg

RSC50 2.0 B

1 050001011

2000
700
1495

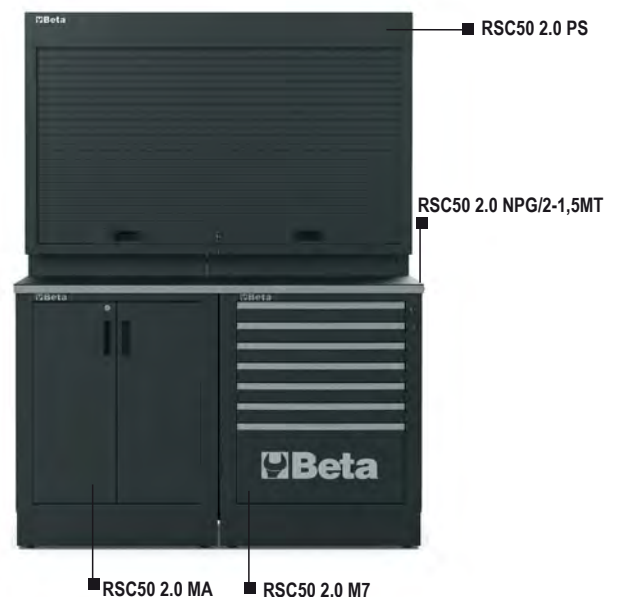

RSC50 2.0 A

workshop equipment combination RSC50 2.0

Combination comprising the following:

- 1 worktop, 1,495x700 mm (RSC50 2.0 NPG/2-1.5MT)
- 1 fixed module with 7 drawers (RSC50 2.0 M7)
- 1 fixed service module with 2 drawers (RSC50 2.0 MS-2C)
- 2 wall-mounted cabinets (RSC50 2.0 PM)
- 2 upper perforated tool panels (RSC50 2.0 PFS)
- 2 lower perforated tool panels (RSC50 2.0 PFI)
- 2 pairs of right/left uprights (RSC50 2.0 P/2MDX-SX)

212 kg

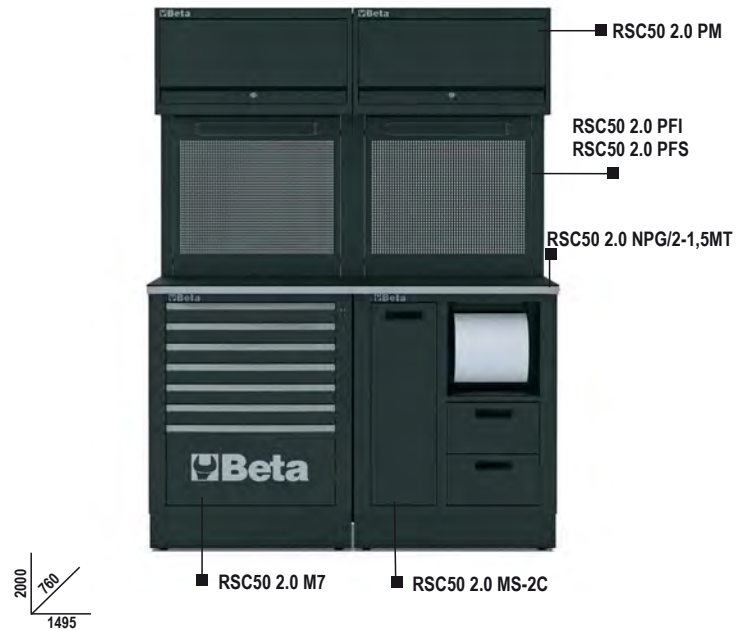

RSC50 2.0 A

1 050001006

RSC50 2.0 NP/1-0,7MT

worktop made from sheet metal, 0.75 m long, for workbench, for workshop equipment combination RSC50 2.0

Worktop (750x700 mm) made from painted sheet metal covered with a shockproof, non-scratch PVC coat, resistant to hydrocarbons. Supplied complete with two exterior side pads.

Holes on both sides for a vice (1599P/125, to be ordered separately). Designed for application of aluminium profiles with LED strip item 5000 RSC50 2.0/PLEDC or 5000 RSC50 2.0/PLED-ST (to be ordered separately), to light under-workbench modules.

16,7 kg

RSC50 2.0 NPA/1-0,7MT 1 050001117
RSC50 2.0 NPG/1-0,7MT 1 050001118

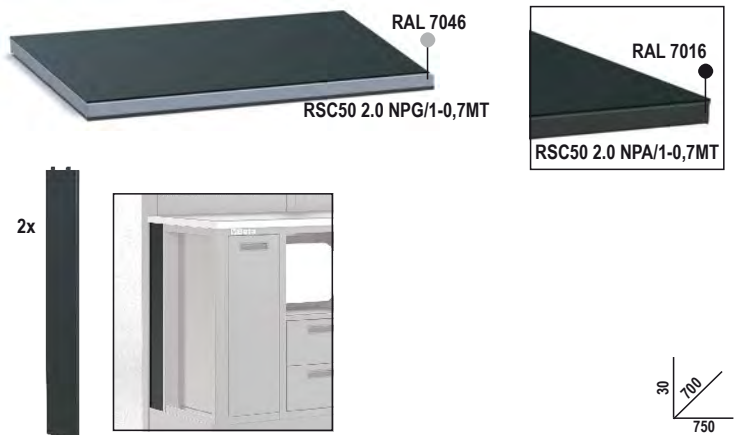

RSC50 2.0 NP/2-1,5MT

worktop made from sheet metal, 1.5 m long, for workbench, for workshop equipment combination RSC50 2.0

Worktop (1,495x700 mm) made from painted sheet metal covered with a shockproof, non-scratch PVC coat, resistant to hydrocarbons. Supplied complete with two side pads.

Holes on both sides for a vice (1599P/125, to be ordered separately). Designed for application of aluminium profiles with LED strip item 5000 RSC50 2.0/PLEDC or 5000 RSC50 2.0/PLED-ST (to be ordered separately), to light under-workbench modules.

31 kg

RSC50 2.0 NPA/2-1,5MT 1 050001124
RSC50 2.0 NPG/2-1,5MT 1 050001125

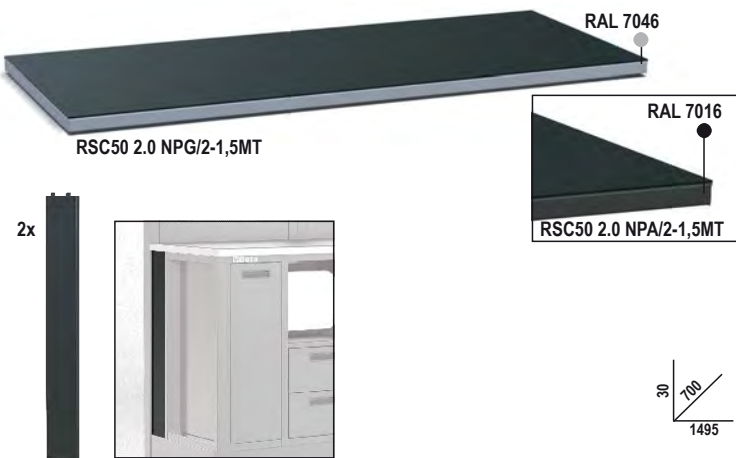

RSC50 2.0 NP/3-2,2MT

worktop made from sheet metal, 2.2 m long,
for workbench, for workshop equipment combination RSC50 2.0

Worktop (2,240x700 mm) made from painted sheet metal covered with a shockproof, non-scratch PVC coat, resistant to hydrocarbons. Supplied complete with two exterior side pads.

Holes on both sides for a vice (1599P/125, to be ordered separately). Designed for application of aluminium profiles with LED strip item 5000 RSC50 2.0/PLEDC or 5000 RSC50 2.0/PLED-ST (to be ordered separately), to light under-workbench modules.

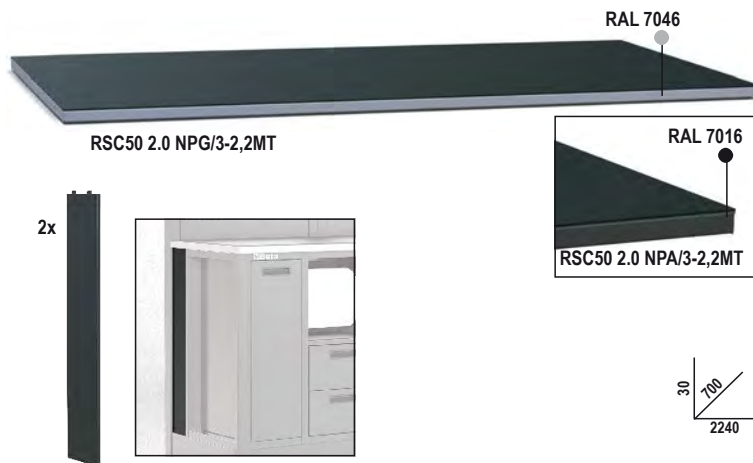

49,6 kg

RSC50 2.0 NPA/2-2,2MT	1	050001132
RSC50 2.0 NPG/2-2,2MT	1	050001133

RSC50 2.0 PW/1-0,7MT

worktop made from multi-ply wood, 0.75 m long,
for workbench, for workshop equipment combination RSC50 2.0

Worktop (750x700 mm) made from multi-ply wood. Supplied complete with two exterior side pads.

Can accommodate a vice (1599P/125, to be ordered separately)

7 kg

RSC50 2.0 PW/1-0,7MT	1	050001126
----------------------	---	-----------



RSC50 2.0 PX/1-0,7MT

worktop made from stainless steel coated MDF, 0.75 m long,
for workbench,
for workshop equipment combination RSC50 2.0

Worktop (750x700 mm) made from stainless steel coated MDF. Supplied complete with two exterior side pads.

Can accommodate a vice (1599P/125, to be ordered separately)

13,5 kg

RSC50 2.0 PX/1-0,7MT	1	050001127
----------------------	---	-----------



RSC50 2.0 PW/2-1,5MT

worktop made from multi-ply wood, 1.5 m long,
for workbench, for workshop equipment combination RSC50 2.0

Worktop (1,495x700 mm) made from multi-ply wood. Supplied complete with two exterior side pads.

Can accommodate a vice (1599P/125, to be ordered separately)

14,5 kg

RSC50 2.0 PW/2-1,5MT	1	050001130
----------------------	---	-----------



RSC50 2.0 PX/2-1,5MT

worktop made from stainless steel coated MDF, 1.5 m long, for
workshop equipment combination RSC50 2.0

Worktop (1,495x700 mm) made from stainless steel coated MDF. Supplied complete with two exterior side pads.

Can accommodate a vice (1599P/125, to be ordered separately)

27 kg

RSC50 2.0 PX/2-1,5MT	1	050001131
----------------------	---	-----------



RSC50 2.0 PW/3-2,2MT

worktop made from multi-ply wood, 2.2 m long, for workbench, for workshop equipment combination RSC50 2.0

Worktop (2,240x700 mm) made from multi-ply wood
Supplied complete with two exterior side pads.



Can accommodate a vice (1599P/125, to be ordered separately)

21 kg

RSC50 2.0 PW/3-2,2MT

1 050001136

RSC50 2.0 PX/3-2,2MT

worktop made from stainless steel coated MDF, 2.2 m long, for workbench, for workshop equipment combination RSC50 2.0

Worktop (2,240x700 mm) made from stainless steel coated MDF.
Supplied complete with two exterior side pads.



Can accommodate a vice (1599P/125, to be ordered separately)

40,5 kg

RSC50 2.0 PX/3-2,2MT

1 050001137

RSC50 2.0 RB

shock-proof, non-scratch PVC coat, resistant to hydrocarbons, for workshop equipment combination RSC50

A must-have for protecting worktops.

RSC50 RB/0.63: for corner worktop, 630x630 mm

RSC50 RB/0.75: for 750-mm-long worktop

RSC50 RB/1.5: for 1,495-mm-long worktop

RSC50 RB/2.2: for 2,240-mm-long worktop



RSC50 RB/0,63

1 050001140

RSC50 RB/0,75

1 050001141

RSC50 RB/1,5

1 050001142

RSC50 RB/2,2

1 050001143

RSC50 2.0 C5

mobile roller cab with 5 drawers, for workshop equipment combination RSC50 2.0

- 5 drawers (588x367 mm) with ball bearing slides
- 4 swivel castors, Ø 100 mm (2 with brakes)
- Drawer bases protected by foamed rubber mats
- Front centralized lock
- Handles built into frame for improved ease of handling
- Each drawer can accommodate up to 4 EVA foam or ABS thermoformed trays

58 kg

RSC50 2.0 C5

1 050001205

h	max
70 mm	25 kg
140 mm	30 kg
280 mm	35 kg

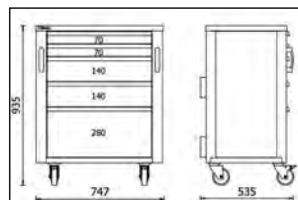
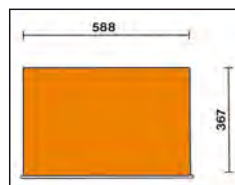

800 kg



RSC50 2.0 C6

mobile roller cab with 6 drawers, for workshop equipment combination
RSC50 2.0

- 6 drawers (588x367 mm) with ball bearing slides
- 4 steering castors, Ø 100 mm (2 with brakes)
- Drawer bases protected by foamed rubber mats
- Front centralized lock
- Handles built into frame for improved ease of handling
- Each drawer can accommodate up to 4 EVA foam or ABS thermoformed trays

61 kg

h	max
70 mm	25 kg
140 mm	30 kg
280 mm	35 kg

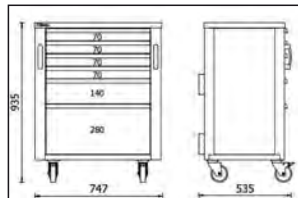
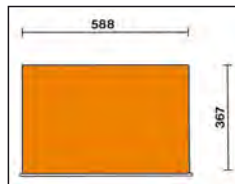

800 kg



RSC50 2.0 C6

1 050001206

RSC50 2.0 C7

mobile roller cab with 7 drawers, for workshop equipment combination
RSC50 2.0

- 7 drawers (588x367 mm) with ball bearing slides
- 4 swivel castors, Ø 100 mm (2 with brakes)
- Drawer bases protected by foamed rubber mats
- Front centralized lock
- Handles built into frame for improved ease of handling
- Each drawer can accommodate up to 4 EVA foam or ABS thermoformed trays

62 kg

h	max
70 mm	25 kg
280 mm	35 kg

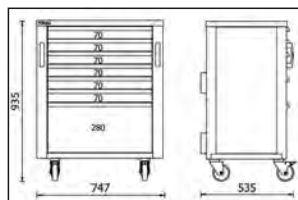
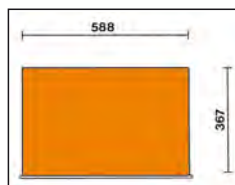

800 kg



RSC50 2.0 C7

1 050001207

Beta

RSC50 2.0 C8

mobile roller cab with 8 drawers, for workshop equipment combination
RSC50 2.0

- 8 drawers (588x367 mm) with ball bearing slides
- 4 swivel castors, Ø 100 mm (2 with brakes)
- Drawer bases protected by foamed rubber mats
- Front centralized lock
- Handles built into frame for improved ease of handling
- Each drawer can accommodate up to 4 EVA foam or ABS thermoformed trays

64 kg

h	max
70 mm	25 kg
140 mm	30 kg

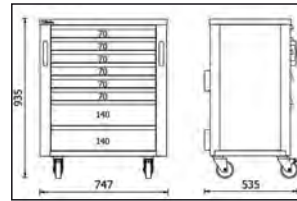
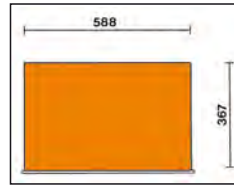

800 kg



RSC50 2.0 C8

1 050001208

RSC50 2.0 M4

fixed module with 4 drawers, for workshop equipment combination
RSC50 2.0

- 4 drawers (588x367 mm) with ball bearing slides
- Drawer bases protected by foamed rubber mats
- Front centralized lock
- With vertically adjustable feet
- Each drawer can accommodate up to 4 EVA foam or ABS thermoformed trays

61,5 kg

h	max
140 mm	30 kg
280 mm	35 kg

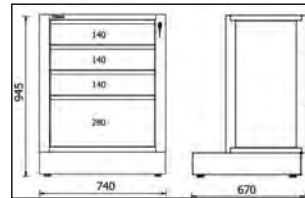
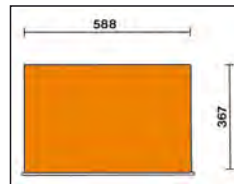

RSC50 2.0 M4

1 050001264

RSC50 2.0 M5

fixed module with 5 drawers, for workshop equipment combination
RSC50 2.0

- 5 drawers (588x367 mm) with ball bearing slides
- Drawer bases protected by foamed rubber mats
- Front centralized lock
- With vertically adjustable feet
- Each drawer can accommodate up to 4 EVA foam or ABS thermoformed trays

63,5 kg

h	max
70 mm	25 kg
140 mm	30 kg
280 mm	35 kg

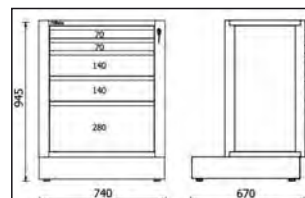
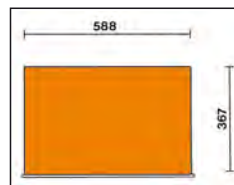

RSC50 2.0 M5

1 050001265

RSC50 2.0 M6

fixed module with 6 drawers, for workshop equipment combination
RSC50 2.0

- 6 drawers (588x367 mm) with ball bearing slides
- Drawer bases protected by foamed rubber mats
- Front centralized lock
- With vertically adjustable feet
- Each drawer can accommodate up to 4 EVA foam or ABS thermoformed trays

65,5 kg

h	max
70 mm	25 kg
140 mm	30 kg
280 mm	35 kg

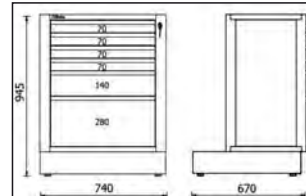
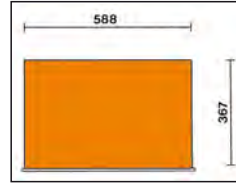

RSC50 2.0 M6

1 050001226

RSC50 2.0 M7

fixed module with 7 drawers, for workshop equipment combination
RSC50 2.0

- 7 drawers (588x367 mm) with ball bearing slides
- Drawer bases protected by foamed rubber mats
- Front centralized lock
- With vertically adjustable feet
- Each drawer can accommodate up to 4 EVA foam or ABS thermoformed trays

67,5 kg

h	max
70 mm	25 kg
280 mm	35 kg

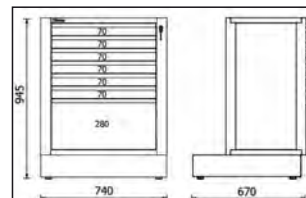
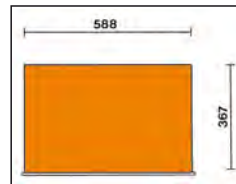

RSC50 2.0 M7

1 050001267

RSC50 2.0 M8

fixed module with 8 drawers, for workshop equipment combination
RSC50 2.0

- 8 drawers (588x367 mm) with ball bearing slides
- Drawer bases protected by foamed rubber mats
- Front centralized lock
- With vertically adjustable feet
- Each drawer can accommodate up to 4 EVA foam or ABS thermoformed trays

69,5 kg

h	max
70 mm	25 kg
140 mm	30 kg

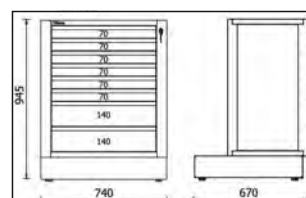
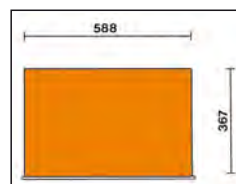

RSC50 2.0 M8

1 050001268

RSC50 2.0 M10

fixed module with 10 drawers, for workshop equipment combination RSC50 2.0

- 10 drawers (588x367 mm) with ball bearing slides
- Drawer bases protected by foamed rubber mats
- Front centralized lock
- With vertically adjustable feet
- Each drawer can accommodate up to 4 EVA foam or ABS thermoformed trays

h	max
70 mm	25 kg

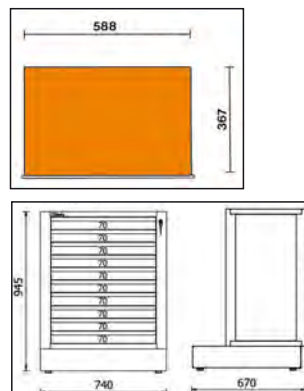

76 kg

RSC50 2.0 M10

1 050001231

RSC50 2.0 MS-2C

fixed service module, for workshop equipment combination RSC50 2.0

- Built-in waste bin
- Paper roll compartment
- Two drawers, 310x370 mm, 180 mm high, with ball bearing slides (interior dimensions)
- With vertically adjustable feet

49 kg

RSC50 2.0 MS-2C

1 050001283

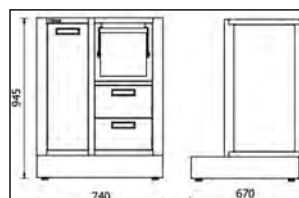

RSC50 2.0 MS-AVV

fixed service module, for workshop equipment combination RSC50 2.0, empty

Can accommodate one reel, to be chosen from the following models:

- compressed air hose reel item 1900S 8x10
- cable reels items 1843 15-H05, 1844 10-H05, 1844 15-H05, 1844 15-H07, 1844 15-H05/SCK, 1844 15-H07/SCK, 1845 12-H05, 1846 10-H05, 1846 10-H07 and 1846 15-H05

- Built-in waste bin
- Paper roll compartment
- With vertically adjustable feet

49 kg

RSC50 2.0 MS-AVV

1 050001281

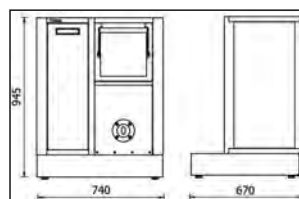

RSC50 2.0 MS-2AVV

fixed service module, for workshop equipment combination RSC50 2.0, empty

Can accommodate two reels, to be chosen from the following models:

- compressed air hose reel item 1900S 8x10
- cable reels items 1843 15-H05, 1844 10-H05, 1844 15-H05, 1844 15-H07, 1844 15-H05/SCK, 1844 15-H07/SCK, 1845 12-H05, 1846 10-H05, 1846 10-H07 and 1846 15-H05

- Built-in waste bin
- Paper roll compartment
- With vertically adjustable feet

50 kg

RSC50 2.0 MS-2AVV

1 050001282

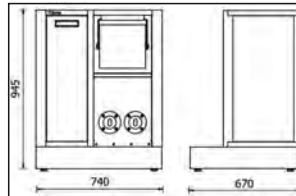

RSC50 2.0 MA

fixed two-door module, for workshop equipment combination RSC50 2.0

- With lock
- Vertically adjustable interior shelf
- Interior dimensions: 615x435x740 mm
- With vertically adjustable feet

46 kg

RSC50 2.0 MA

1 050001262

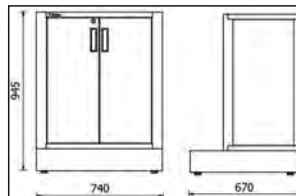

RSC50 2.0 CS

fixed sorted waste collection module, for workshop equipment combination RSC50 2.0

- Pull-out waste compartment (588x355x580 mm) with ball bearing slides
- 2 capacious pull-out interior containers for sorting waste
- With vertically adjustable feet

48 kg

RSC50 2.0 CS

1 050001285

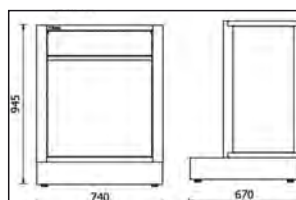

RSC50 2.0 ML

fixed module with built-in sink, for workshop equipment combination
RSC50 2.0

Technical specifications:

- Stainless steel basin
- Supplied complete with:
 - 1 mixer tap
 - 1 drain unit
 - 1 sink stopper
 - 1 filter cap
 - 1 soap dispenser

Fixed two-door module with lock:

- Usable interior dimensions: 615x435x575 mm
- With vertically adjustable feet

39 kg

RSC50 2.0 ML

1 050001284

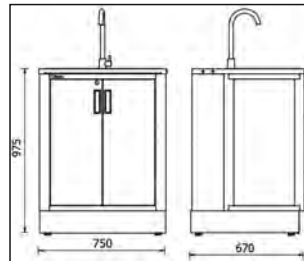

RSC50 2.0 MDO

fixed oil distribution module for workshop equipment combination
RSC50 2.0

- 2 hose reels 7 m - 1/2" included
- Complete with 2 guns with digital litre counter and automatic drip catcher.
 - Max. flow rate: 30 l/min
 - Viscosity: 8÷2000 mPas
- With vertically adjustable feet

92 kg

RSC50 2.0 MDO

1 050001290

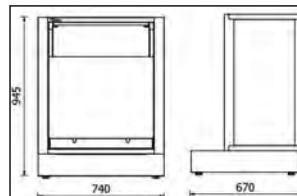

RSC50 2.0 T3

3-tier tool trolley, for workshop equipment combination RSC50 2.0

- 4 swivel castors, Ø 100 mm (two with brakes)
- Static load capacity: 200 kg (distributed over 3 shelves)

23 kg

RSC50 2.0 T3

1 050001253

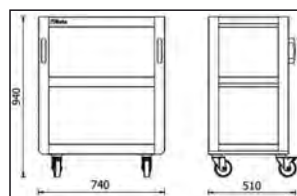

RSC50 2.0 KPF

kit of perforated tool panels, for workshop equipment combination RSC50 2.0

Kit contents:

- One upper perforated tool panel, 650x400x25 mm
- One lower perforated tool panel, 650x625x25 mm, can accommodate a 19" rack multi-socket (not included)
- One pair of right/left uprights

17,5 kg

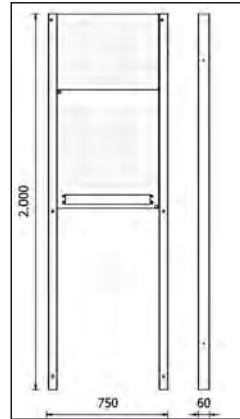
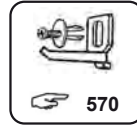

RSC50 2.0 KPF



RSC50 2.0 PFS

upper perforated tool panel, for workshop equipment combination RSC50 2.0

- Perforated tool panel, 650x400x25 mm

3 kg

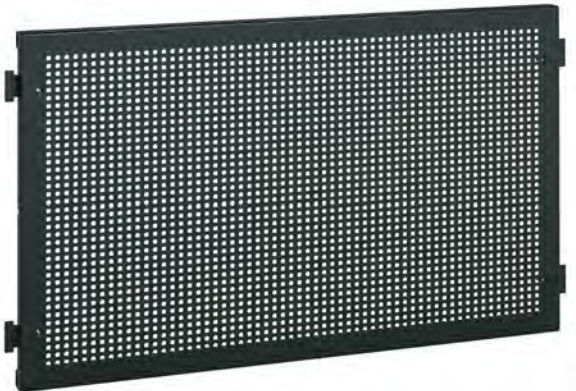

RSC50 2.0 PFS



RSC50 2.0 PFI

lower perforated tool panel, for workshop equipment combination RSC50 2.0

- Lower perforated tool panel, 650x625x25 mm
- Can accommodate a 19" rack multi-socket (not included)

4,5 kg

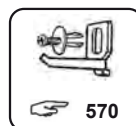

RSC50 2.0 PFI



RSC50 2.0 P/2MDX-SX

pair of right/left uprights for perforated tool wall systems, for workshop equipment combination RSC50 2.0

8,5 kg

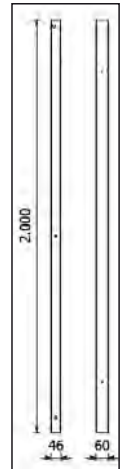

RSC50 2.0 P/2MDX-SX

1 050001352

RSC50 2.0 PM

wall-mounted cabinet, for workshop equipment combination RSC50 2.0

- Dimensions: 740x300x400 mm
- Fitted with gas springs, making it easier to open and close door
- Designed for application of aluminium profiles with LED strip item 5000 RSC50 2.0/PLEDC or 5000 RSC50 2.0/PLED-ST (to be ordered separately), to light working area beneath and/or interior of suspended cabinet.

15 kg



30 kg

RSC50 2.0 PM

1 050001302

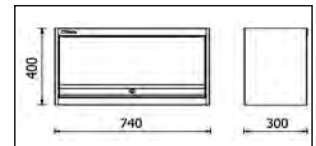

RSC50 2.0 MTP

triangular shelf, for workshop equipment combination RSC50 2.0

- Dimensions: 740x300x400 mm
- Designed for application of aluminium profiles with LED strip item 5000 RSC50 2.0/PLEDC or 5000 RSC50 2.0/PLED-ST (to be ordered separately), to light working area beneath

5 kg



10 kg

RSC50 2.0 MTP

1 050001305



Beta



RSC50 2.0 PS

tool wall system with shutter, for workshop equipment combination
RSC50 2.0

- Aluminium shutter, vertically adjustable, with lock
- Removable perforated tool panels
- Supplied with framework
- 50-hook GPS kit included

80 kg

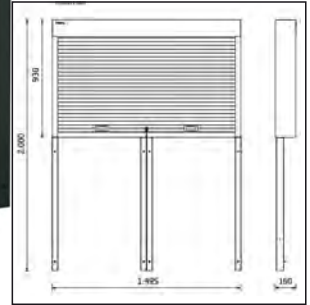

RSC50 2.0 PS

1 050001360

RSC50 2.0 NAC

self-supporting complete corner, for workshop equipment combination
RSC50 2.0

- Corner worktop (964x964) made from painted sheet metal covered with a shockproof, non-scratch PVC coat, resistant to hydrocarbons
- Suspended corner cabinet with lock and gas springs, making it easier to open and close door
- 2 perforated tool panels (869x1,027 mm)
- Lower corner module with large storage compartment
- With vertically adjustable feet

143 kg



RSC50 2.0 NAC-A

RAL 7016

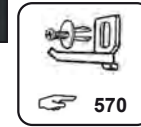

RAL 7046

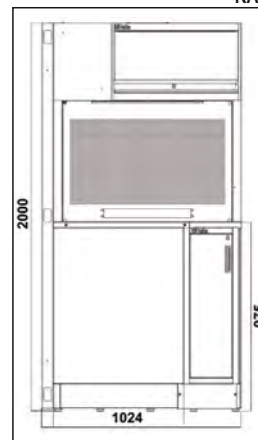

RSC50 2.0 NAC-G

RSC50 2.0 NAC-A

1 050001339

RSC50 2.0 NAC-G

1 050001340

 **Beta**

RSC50 2.0 NAC-W

self-supporting complete corner, for workshop equipment combination RSC50 2.0

- Corner worktop (964x964 mm) made from multi-ply wood
- Suspended corner cabinet with lock and gas springs, making it easier to open and close door
- 2 perforated tool panels (869x1,027 mm)
- Lower corner module with large storage compartment
- With vertically adjustable feet

139 kg

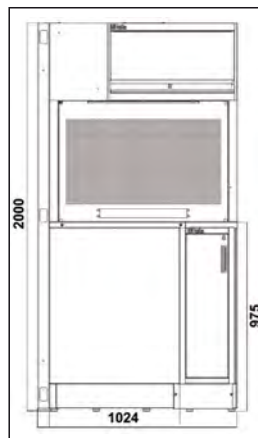
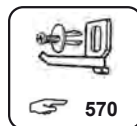

RSC50 2.0 NAC-W

RSC50 2.0 NAC-W



RSC50 2.0 NAC-X

self-supporting complete corner, for workshop equipment combination RSC50 2.0

- Corner worktop (964x964 mm) made from stainless steel coated MDF
- Suspended corner cabinet with lock and gas springs, making it easier to open and close door
- 2 perforated tool panels (869x1,027 mm)
- Lower corner module with large storage compartment
- With vertically adjustable feet

148 kg

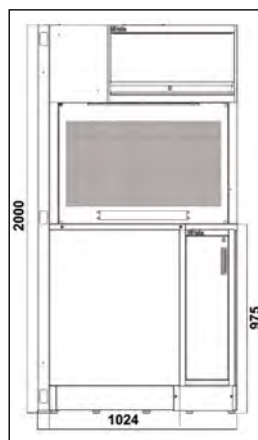
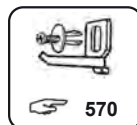

RSC50 2.0 NAC-X

RSC50 2.0 NAC-X



RSC50 2.0 KNAI

lower corner module, for workshop equipment combination RSC50 2.0

- Worktop (964x964 mm) made from painted sheet metal covered with a shockproof, non-scratch PVC coat, resistant to hydrocarbons
- Fixed corner module with large storage compartment
- With vertically adjustable feet

80 kg

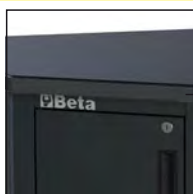

RSC50 2.0 KNAI-A

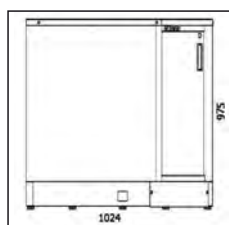

RSC50 2.0 KNAI-G

RSC50 2.0 KNAI-A



RSC50 2.0 KNAI-G

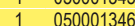

RSC50 2.0 KNAI-W

lower corner module, for workshop equipment combination RSC50 2.0

- Corner worktop (964x964 mm) made from multi-ply wood
- Fixed corner module with large storage compartment
- With vertically adjustable feet

76 kg

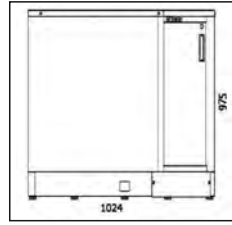

RSC50 2.0 KNAI-W

RSC50 2.0 KNAI-W

1 050001337

RSC50 2.0 KNAI-X

lower corner module, for workshop equipment combination RSC50 2.0

- Corner worktop (964x964 mm) made from stainless steel coated MDF
- Fixed corner module with large storage compartment
- With vertically adjustable feet

85 kg

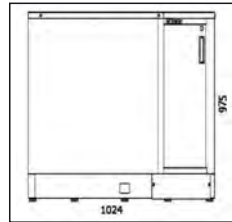

RSC50 2.0 KNAI-X

RSC50 2.0 KNAI-X

1 050001338

RSC50 2.0 A1

sheet metal single-door tool cabinet, for workshop equipment combination RSC50 2.0

- 4 removable, vertically adjustable shelves
- Convenient folding clothes rail under first shelf
- With lock
- Interior dimensions: 590x615 mm
- With vertically adjustable feet

67 kg

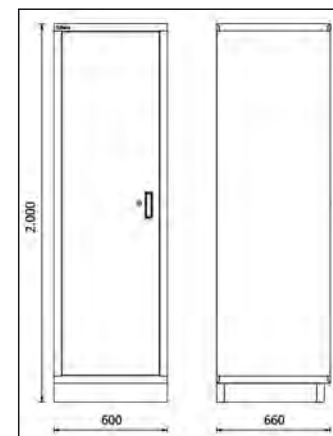

RSC50 2.0 A1

1 050001411

RSC50 2.0 A1/R59

interior shelf for tool cabinet RSC50 A1

3,1 kg

30 kg



RSC50 2.0 A1/R59 605x596 mm

1 050001913

RSC50 2.0 A1/RB59

interior shelf for tool cabinet RSC50 A1, with clothes rail

3,4 kg

RSC50 2.0 A1/RB59 605x596 mm

1 050001914

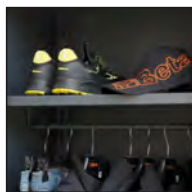

RSC50 2.0 A2

sheet metal two-door tool cabinet, for workshop equipment combination RSC50 2.0

- 4 removable, vertically adjustable shelves
- With lock
- Interior dimensions: 910x615 mm
- With vertically adjustable feet

85 kg

RSC50 2.0 A2

1 050001412



RSC50 2.0 A2/3C

sheet metal two-door tool cabinet with 3 drawers, for workshop equipment combination RSC50 2.0

- 4 removable, vertically adjustable shelves
- **Supplied complete with 3-drawer (681x360 mm) module**
- Front lock
- Interior dimensions: 910x615 mm
- With vertically adjustable feet

105,50 kg

RSC50 2.0 A2/3C

1 050001413

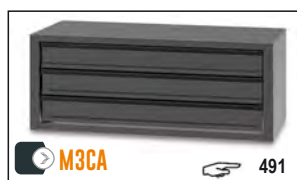

RSC50 2.0 A2/R91

interior shelf for tool cabinet RSC50 A2

4,2 kg

RSC50 2.0 A2/R91 911x596 mm

1 050001915



5000 RSC50 2.0/MP

shelf, for workshop equipment combination RSC50 2.0

- Dimensions: 740x140x80 mm
- Designed for application of aluminium profiles with LED strip item 5000 RSC50 2.0/PLEDC or 5000 RSC50 2.0/PLED-ST (to be ordered separately), to light working area beneath

2,0 kg

5000 RSC50 2.0/MP

1 050001705



5000 RSC50/MPA140

corner shelf, 140 mm deep, for workshop equipment combination RSC50

- Dimensions: 630x630x35 mm, 140 mm deep
- Designed for application of aluminium profiles with LED strip item 5000 RSC50 2.0/PLEDC or 5000 RSC50 2.0/PLED-ST (to be ordered separately), to light working area beneath

3,8 kg

5000 RSC50/MPA140

1 050001706



5000 RSC50 2.0/CLL

linear guard for workshop equipment combination RSC50 2.0

- Dimensions: 740x125x30 mm
- To be applied to perforated tool panels
- Designed for application of aluminium profiles with LED strip item 5000 RSC50 2.0/PLEDC or 5000 RSC50 2.0/PLED-ST (to be ordered separately), to light working area beneath

1 kg

5000 RSC50 2.0/CLL

1 050001710



5000 RSC50/CAL

corner guard, for workshop equipment combination RSC50

- Dimensions: 655x655x30 mm
- Designed for application of aluminium profiles with LED strip item 5000 RSC50 2.0/PLEDC or 5000 RSC50 2.0/PLED-ST (to be ordered separately), to light working area beneath

1,2 kg

5000 RSC50/CAL

1 050001711



5000 RSC50 2.0/KFC

kit of 10 coloured drawer fronts, for workshop equipment combination RSC50 2.0

To customize colour of drawer fronts for workshop equipment combination RSC50 2.0.

Recommended for use in combination with worktops in anthracite grey RAL7016 (-A).

5000 RSC50 2.0/KFC2011



1 050001731

5000 RSC50 2.0/KFC3000



1 050001733

5000 RSC50 2.0/KFC5015



1 050001734

5000 RSC50 2.0/KFC7016



1 050001737





WORKSHOP EQUIPMENT C45PRO 2.0

WE ARE PROUD TO INTRODUCE THE 2.0 VERSION OF OUR SUCCESSFUL RANGE, C45PRO.

Based on the new **61.5-cm-long worktop**, this range stands out as even more convenient and professional, with a view to increasingly meeting the most demanding professionals' requirements.

The modular workshop equipment, **C45PRO 2.0**, allows you to create your own work environment according to both the amount of space you have available and your usage requirements.

This simple, flexible range based on predetermined combinations, can be expanded or changed in time. Alternatively, you can fully customize your workstation, starting with the worktops – available in stainless steel coated MDF or multi-ply wood – and supplementing them with the numerous parts and accessories you can choose from.

**Tailor your work environment to suit your needs.
Make your workshop or garage look different.
Choose from the preassembled solutions
or create your workstation from scratch.**



Configure your workshop online



go to www.beta-tools.com

Beta

C45PRO 2.0

C45PRO 2.0 DX

workshop equipment combination C45PRO 2.0

Combination comprising the following:

- 1 stainless steel coated MDF worktop, dimensions 2,040x615 mm (C45PRO 2.0 PXE/3-2.0MT)
- 1 stainless steel coated MDF worktop, dimensions 1,360x615 mm (C45PRO 2.0 PXE/2-1.3MT)
- 1 fixed module with 7 drawers (C45PRO 2.0 M7)
- 1 mobile roller cab with 7 drawers (C45PRO 2.0 C7)
- 1 fixed service module (C45PRO 2.0 MS)
- 1 fixed module with 5 drawers (C45PRO 2.0 M5)
- 1 fixed two-door module (C45PRO 2.0 MA)
- 1 self-supporting complete corner with stainless steel coated MDF worktop (C45PRO 2.0 CORNER/X)
- 5 perforated tool panels (C45PRO 2.0 PF)
- 5 wall-mounted cabinets (C45PRO 2.0 PM)
- 7 wall brackets, wide type (C45PRO 2.0 SL)
- 2 wall brackets, narrow type (C45PRO 2.0 SS)
- 2 single-door cabinets (C45PRO 2.0 AS1)

640 kg

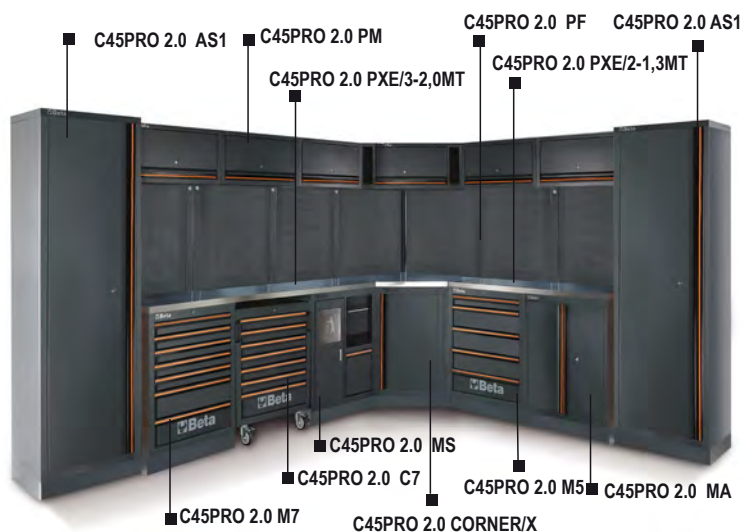

C45PRO 2.0 DW

workshop equipment combination C45PRO 2.0

Combination comprising the following:

- 1 multi-ply wood worktop, dimensions 2,040x615 mm (C45PRO 2.0 PWE/3-2,0MT)
- 1 multi-ply wood worktop, dimensions 1,360x615 mm (C45PRO 2.0 PWE/2-1,3MT)
- 1 fixed module with 7 drawers (C45PRO 2.0 M7)
- 1 mobile roller cab with 7 drawers (C45PRO 2.0 C7)
- 1 fixed service module (C45PRO 2.0 MS)
- 1 fixed module with 5 drawers (C45PRO 2.0 M5)
- 1 fixed two-door module (C45PRO 2.0 MA)
- 1 self-supporting complete corner with multi-ply wood worktop (C45PRO 2.0 CORNER/W)
- 5 perforated tool panels (C45PRO 2.0 PF)
- 5 wall-mounted cabinets (C45PRO 2.0 PM)
- 7 wall brackets, wide type (C45PRO 2.0 SL)
- 2 wall brackets, narrow type (C45PRO 2.0 SS)
- 2 single-door cabinets (C45PRO 2.0 AS1)

606 kg

C45PRO 2.0 DW

1 045002032

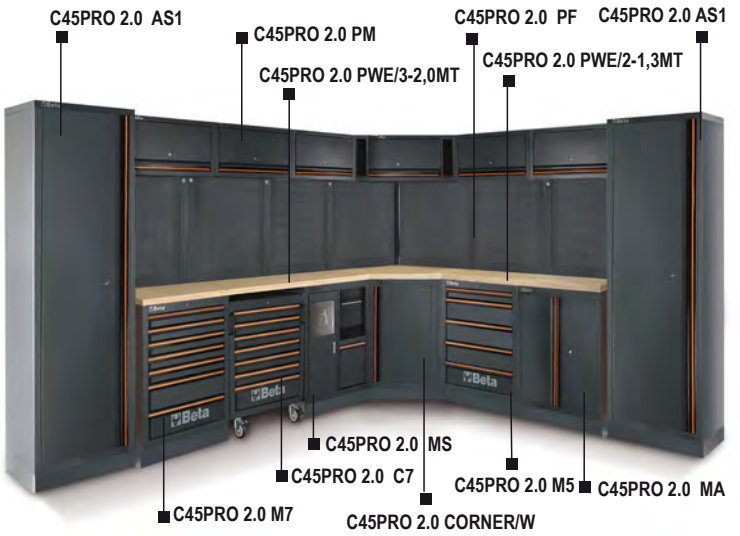

C45PRO 2.0 FX

workshop equipment combination C45PRO 2.0

Combination comprising the following:

- 1 stainless steel coated MDF worktop, dimensions 2,040x615 mm (C45PRO 2.0 PXE/3-2,0MT)
- 1 stainless steel coated MDF worktop, dimensions 1,360x615 mm (C45PRO 2.0 PXE/2-1,3MT)
- 1 fixed two-door module (C45PRO 2.0 MA)
- 1 mobile roller cab with 7 drawers (C45PRO 2.0 C7)
- 1 fixed module with 7 drawers (C45PRO 2.0 M7)
- 1 fixed module with 2 built-in reels (C45PRO 2.0 ACT)
- 1 fixed service module (C45PRO 2.0 MS)
- 1 self-supporting complete corner with stainless steel coated MDF worktop (C45PRO 2.0 CORNER/X)
- 2 perforated tool panels (C45PRO 2.0 PF)
- 1 perforated tool panel, can be fitted with a power socket (not included) (C45PRO 2.0 PFE)
- 3 wall-mounted cabinets (C45PRO 2.0 PM)
- 1 tool wall system with aluminium shutter (C45PRO 2.0 PAS)
- 6 wall brackets, wide type (C45PRO 2.0 SL)
- 4 wall brackets, narrow type (C45PRO 2.0 SS)
- 2 single-door cabinets (C45PRO 2.0 AS1)

658 kg

C45PRO 2.0 FX

1 045002035

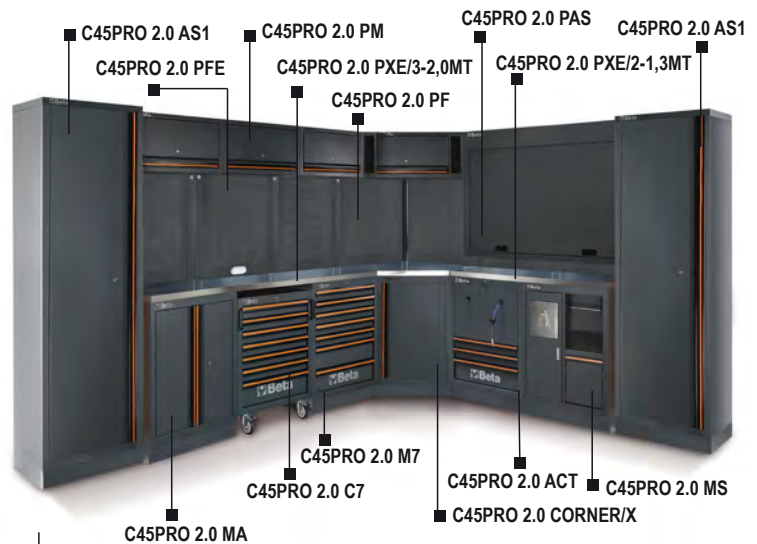

C45PRO 2.0 FW

workshop equipment combination C45PRO 2.0

Combination comprising the following:

- 1 multi-ply wood worktop, dimensions 2,040x615 mm (C45PRO 2.0 PWE/3-2,0MT)
- 1 multi-ply wood worktop, dimensions 1,60x615 mm (C45PRO 2.0 PWE/2-1,3MT)
- 1 fixed two-door module (C45PRO 2.0 MA)
- 1 mobile roller cab with 7 drawers (C45PRO 2.0 C7)
- 1 fixed module with 7 drawers (C45PRO 2.0 M7)
- 1 fixed module with 2 built-in reels (C45PRO 2.0 ACT)
- 1 fixed service module (C45PRO 2.0 MS)
- 1 self-supporting complete corner with multi-ply wood worktop (C45PRO 2.0 CORNER/W)
- 2 perforated tool panels (C45PRO 2.0 PF)
- 1 perforated tool panel, can be fitted with a power socket (not included) (C45PRO 2.0 PFE)
- 3 wall-mounted cabinets (C45PRO 2.0 PM)
- 1 tool wall system with aluminium shutter (C45PRO 2.0 PAS)
- 6 wall brackets, wide type (C45PRO 2.0 SL)
- 4 wall brackets, narrow type (C45PRO 2.0 SS)
- 2 single-door cabinets (C45PRO 2.0 AS1)

625 kg

C45PRO 2.0 FW

1 045002045

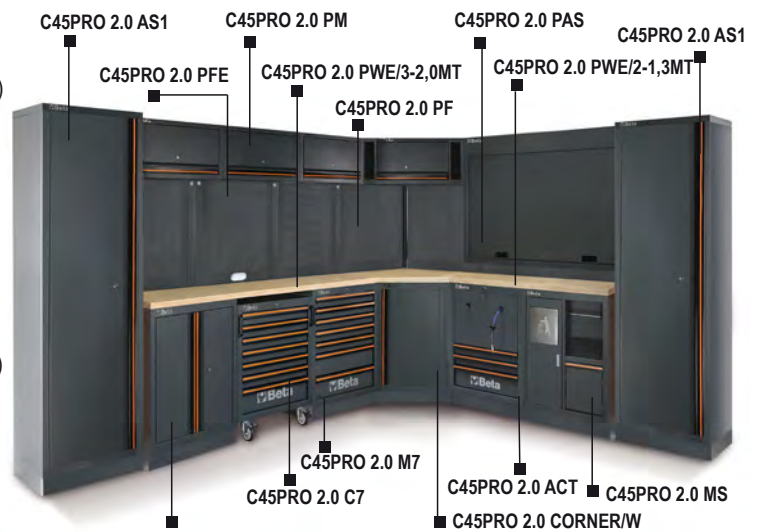

C45PRO 2.0 GX

workshop equipment combination C45PRO 2.0

Combination comprising the following:

- 1 stainless steel coated MDF worktop, dimensions 2,040x615 mm (C45PRO 2.0 PXE/3-2.0MT)
- 1 stainless steel coated MDF worktop, dimensions 680x615 mm (C45PRO 2.0 PXE/1-0.7MT)
- 1 fixed module with 2 built-in reels (C45PRO 2.0 ACT)
- 1 mobile roller cab with 7 drawers (C45PRO 2.0 C7)
- 1 fixed module with 7 drawers (C45PRO 2.0 M7)
- 1 fixed two-door module (C45PRO 2.0 MA)
- 1 self-supporting complete corner with stainless steel coated MDF worktop (C45PRO 2.0 CORNER/X)
- 1 perforated tool panel (C45PRO 2.0 PF)
- 1 perforated tool panel, can be fitted with a power socket (not included) (C45PRO 2.0 PFE)
- 2 wall-mounted cabinets (C45PRO 2.0 PM)
- 1 tool wall system with aluminium shutter (C45PRO 2.0 PAS)
- 5 wall brackets, wide type (C45PRO 2.0 SL)
- 4 wall brackets, narrow type (C45PRO 2.0 SS)
- 2 single-door cabinets (C45PRO 2.0 AS1)

554 kg

C45PRO 2.0 GX

1 045002036

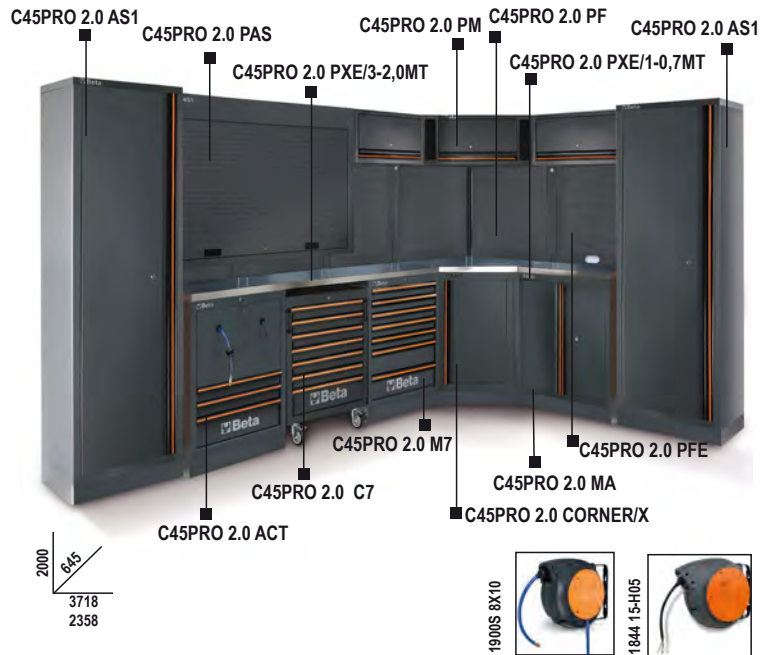

C45PRO 2.0 GW

workshop equipment combination C45PRO 2.0

Combination comprising the following:

- 1 multi-ply wood worktop, dimensions 2,040x615 mm (C45PRO 2.0 PWE/3-2.0MT)
- 1 multi-ply wood worktop, dimensions 680x615 mm (C45PRO 2.0 PWE/1-0.7MT)
- 1 fixed module with 2 built-in reels (C45PRO 2.0 ACT)
- 1 mobile roller cab with 7 drawers (C45PRO 2.0 C7)
- 1 fixed module with 7 drawers (C45PRO 2.0 M7)
- 1 fixed two-door module (C45PRO 2.0 MA)
- 1 self-supporting complete corner with multi-ply wood worktop (C45PRO 2.0 CORNER/W)
- 1 perforated tool panel (C45PRO 2.0 PF)
- 1 perforated tool panel, can be fitted with a power socket (not included) (C45PRO 2.0 PFE)
- 2 wall-mounted cabinets (C45PRO 2.0 PM)
- 1 tool wall system with aluminium shutter (C45PRO 2.0 PAS)
- 6 wall brackets, wide type (C45PRO 2.0 SL)
- 2 wall brackets, narrow type (C45PRO 2.0 SS)
- 2 single-door cabinets (C45PRO 2.0 AS1)

551 kg

C45PRO 2.0 GW

1 045002037

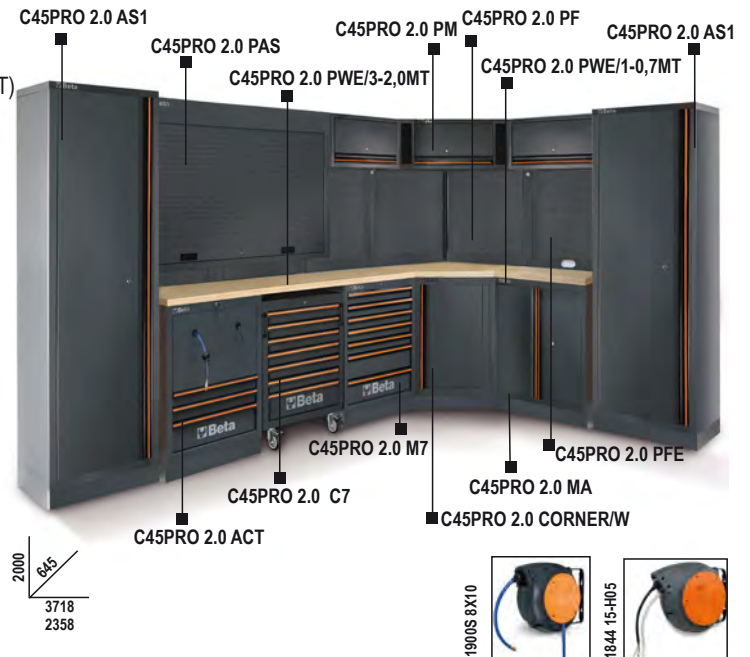

C45PRO 2.0 X

workshop equipment combination C45PRO 2.0

Combination comprising the following:

- Stainless steel coated MDF worktop, dimensions 2,040x615 mm (C45PRO 2.0 PXE/3-2.0MT)
- Fixed module with 7 drawers (C45PRO 2.0 M7)
- Mobile roller cab with 7 drawers (C45PRO 2.0 C7)
- Fixed service module (C45PRO 2.0 MS)
- 3 perforated tool panels (C45PRO 2.0 PF)
- 3 wall-mounted cabinets (C45PRO 2.0 PM)
- 3 wall brackets, wide type (C45PRO 2.0 SL)
- 1 wall bracket, narrow type (C45PRO 2.0 SS)
- Two-door cabinet (C45PRO 2.0 AS2)

334 kg

C45PRO 2.0 X

1 045002001

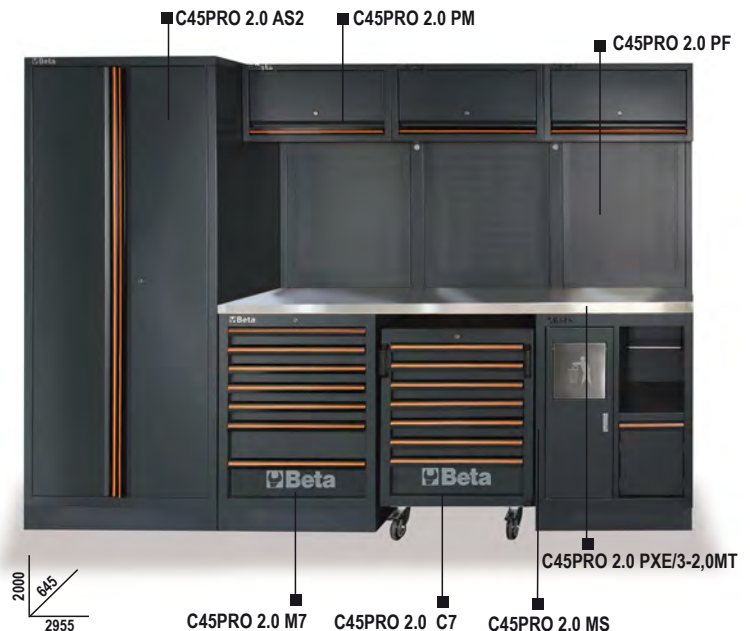

C45PRO 2.0 W

workshop equipment combination C45PRO 2.0

Combination comprising the following:

- Multi-ply wood worktop, dimensions 2.040x615 mm (C45PRO 2.0 PWE/3-2,0MT)
- Fixed module with 7 drawers (C45PRO 2.0 M7)
- Mobile roller cab with 7 drawers (C45PRO 2.0 C7)
- Fixed service module (C45PRO 2.0 MS)
- 3 perforated tool panels (C45PRO 2.0 PF)
- 3 wall-mounted cabinets (C45PRO 2.0 PM)
- 3 wall brackets, wide type (C45PRO 2.0 SL)
- 1 wall bracket, narrow type (C45PRO 2.0 SS)
- Two-door cabinet (C45PRO 2.0 AS2)

318 kg

C45PRO 2.0 W

1 045002002

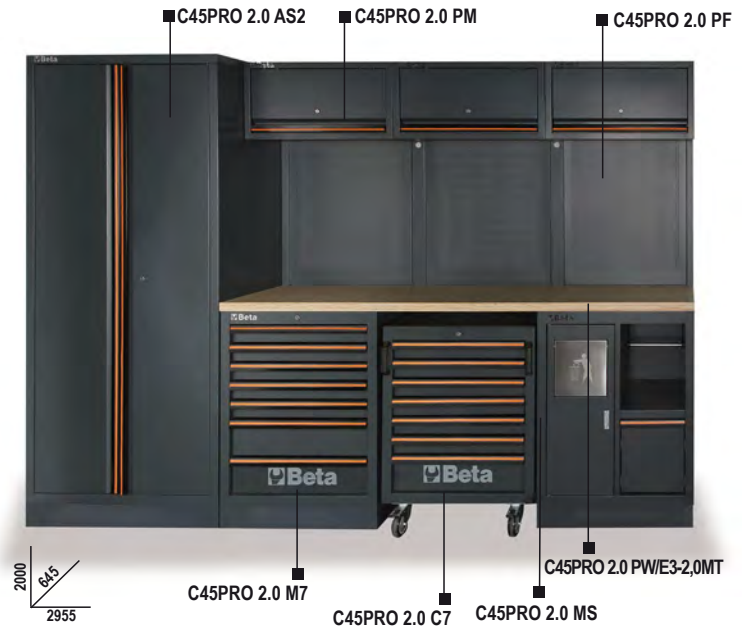

C45PRO 2.0 HX

workshop equipment combination C45PRO 2.0

Combination comprising the following:

- 1 stainless steel coated MDF worktop, dimensions 2,040x615 mm (C45PRO 2.0 PXE/3-2,0MT)
- 1 fixed module with 2 built-in reels (C45PRO 2.0 ACT)
- 1 mobile roller cab with 7 drawers (C45PRO 2.0 C7)
- 1 fixed module with 4 drawers (C45PRO 2.0 M4)
- 3 wall-mounted cabinets (C45PRO 2.0 PM)
- 3 perforated tool panels (C45PRO 2.0 PF)
- 3 wall brackets, wide type (C45PRO 2.0 SL)
- 1 wall bracket, narrow type (C45PRO 2.0 SS)
- 1 two-door cabinet (C45PRO 2.0 AS2)

333 kg

C45PRO 2.0 HX

1 045002038

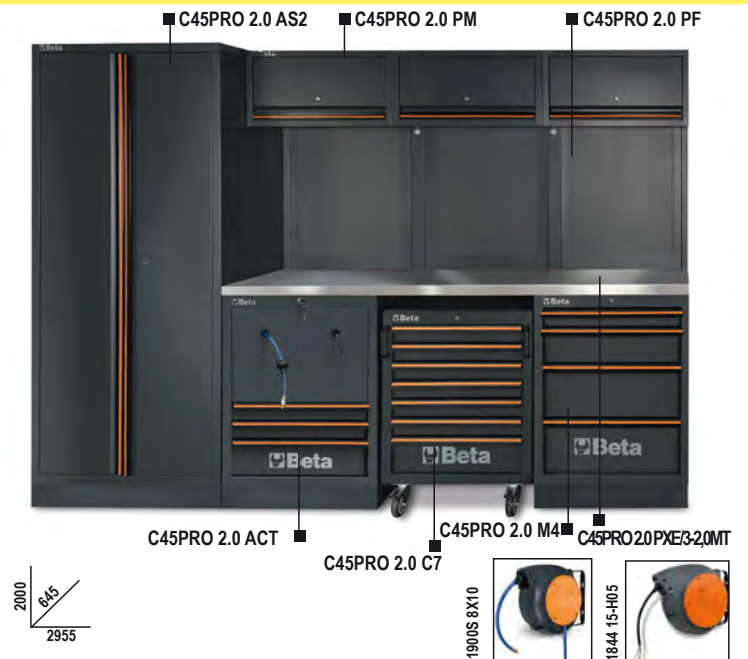

C45PRO 2.0 HW

workshop equipment combination C45PRO 2.0

Combination comprising the following:

- 1 multi-ply wood worktop, dimensions 2,040x615 mm (C45PRO 2.0 PWE/3-2,0MT)
- 1 fixed module with 2 built-in reels (C45PRO 2.0 ACT)
- 1 mobile roller cab with 7 drawers (C45PRO 2.0 C7)
- 1 fixed module with 4 drawers (C45PRO 2.0 M4)
- 3 wall-mounted cabinets (C45PRO 2.0 PM)
- 3 perforated tool panels (C45PRO 2.0 PF)
- 3 wall brackets, wide type (C45PRO 2.0 SL)
- 1 wall bracket, narrow type (C45PRO 2.0 SS)
- 1 two-door cabinet (C45PRO 2.0 AS2)

318 kg

C45PRO 2.0 HW

1 045002039

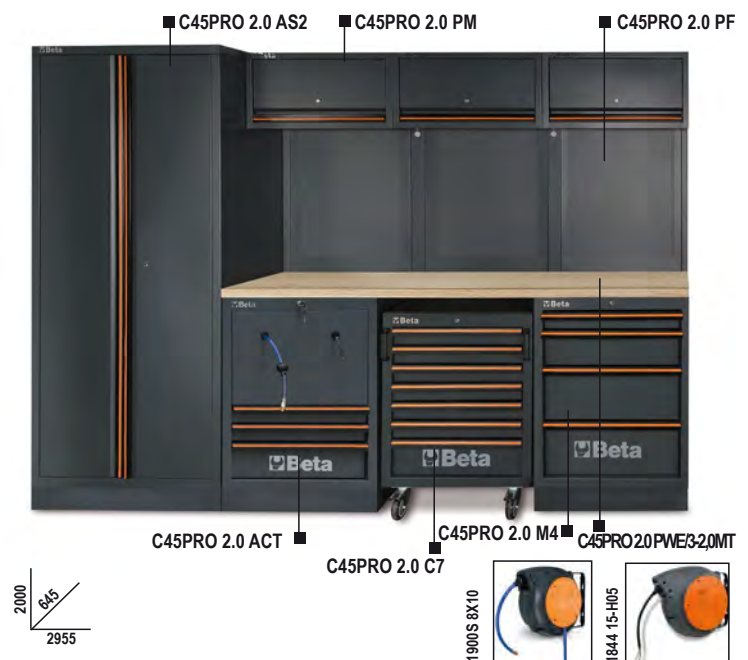

C45PRO 2.0 AX

workshop equipment combination C45PRO 2.0

Combination comprising the following:

- Stainless steel coated MDF worktop, dimensions 2,040x615 mm (C45PRO 2.0 PXE/3-2.0MT)
- Fixed service module (C45PRO 2.0 MS)
- Fixed module with 7 drawers (C45PRO 2.0 M7)
- Fixed two-door module (C45PRO 2.0 MA)
- 3 wall-mounted cabinets (C45PRO 2.0 PM)
- 3 perforated tool panels (C45PRO 2.0 PF)
- 2 wall brackets, wide type (C45PRO 2.0 SL)
- 2 wall brackets, narrow type (C45PRO 2.0 SS)

234,5 kg

C45PRO 2.0 AX

1 045002003



C45PRO 2.0 AW

workshop equipment combination C45PRO 2.0

Combination comprising the following:

- Multi-ply wood worktop, dimensions 2,040x615 mm (C45PRO 2.0 PWE/3-2.0MT)
- Fixed service module (C45PRO 2.0 MS)
- Fixed module with 7 drawers (C45PRO 2.0 M7)
- Fixed two-door module (C45PRO 2.0 MA)
- 3 wall-mounted cabinets (C45PRO 2.0 PM)
- 3 perforated tool panels (C45PRO 2.0 PF)
- 2 wall brackets, narrow type (C45PRO 2.0 SS)
- 2 wall brackets, wide type (C45PRO 2.0 SL)

219 kg

C45PRO 2.0 AW

1 045002004



C45PRO 2.0 BX

workshop equipment combination C45PRO 2.0

Combination comprising the following:

- Stainless steel coated MDF worktop, dimensions 1,360x615 mm (C45PRO 2.0 PXE/2-1.3MT)
- Fixed module with 5 drawers (C45PRO 2.0 M5)
- Fixed two-door module (C45PRO 2.0 MA)
- 2 wall-mounted cabinets (C45PRO 2.0 PM)
- 2 perforated tool panels (C45PRO 2.0 PF)
- 2 wall brackets, wide type (C45PRO 2.0 SL)
- 1 wall bracket, narrow type (C45PRO 2.0 SS)
- Single-door cabinet (C45PRO 2.0 AS1)

206 kg

C45PRO 2.0 BX

1 045002021



C45PRO 2.0 BW

workshop equipment combination C45PRO 2.0

Combination comprising the following:

- Multi-ply wood worktop, dimensions 1,360x615 mm (C45PRO 2.0 PWE/2-1.3MT)
- Fixed module with 5 drawers (C45PRO 2.0 M5)
- Fixed two-door module (C45PRO 2.0 MA)
- 2 wall-mounted cabinets (C45PRO 2.0 PM)
- 2 perforated tool panels (C45PRO 2.0 PF)
- 2 wall brackets, wide type (C45PRO 2.0 SL)
- 1 wall bracket, narrow type (C45PRO 2.0 SS)
- Single-door cabinet (C45PRO 2.0 AS1)

196 kg

C45PRO 2.0 BW

1 045002022



C45PRO 2.0 EX

workshop equipment combination C45PRO 2.0

Combination comprising the following:

- 2 perforated tool panels (C45PRO 2.0 PF)
 - 2 wall-mounted cabinets (C45PRO 2.0 PM)
 - 2 wall brackets, wide type (C45PRO 2.0 SL)
 - 1 wall bracket, narrow type (C45PRO 2.0 SS)
 - 1 single-door cabinet (C45PRO 2.0 AS1)
-
- Fixed module with 7 drawers and stainless steel coated MDF worktop, dimensions 1,360x615 mm (C45PRO 2.0 M7A/X):
 - 1 drawer 1,248x406 mm
 - 6 drawers 782x406 mm
 - 5 drawers 65 mm high
 - 1 drawer 145 mm high
 - 1 storage compartment with intermediate shelf and door

203 kg

C45PRO 2.0 EX

1 045002033



C45PRO 2.0 EW

workshop equipment combination C45PRO 2.0

Combination comprising the following:

- 2 perforated tool panels (C45PRO 2.0 PF)
 - 2 wall-mounted cabinets (C45PRO 2.0 PM)
 - 2 wall brackets, wide type (C45PRO 2.0 SL)
 - 1 wall bracket, narrow type (C45PRO 2.0 SS)
 - 1 single-door cabinet (C45PRO 2.0 AS1)
-
- Fixed module with 7 drawers and multiply wood worktop, dimensions 1,360x615 mm (C45PRO 2.0 M7A/W):
 - 1 drawer 1,248x406 mm
 - 6 drawers 782x406 mm
 - 5 drawers 65 mm high
 - 1 drawer 145 mm high
 - 1 storage compartment with intermediate shelf and door

193 kg

C45PRO 2.0 EW

1 045002034

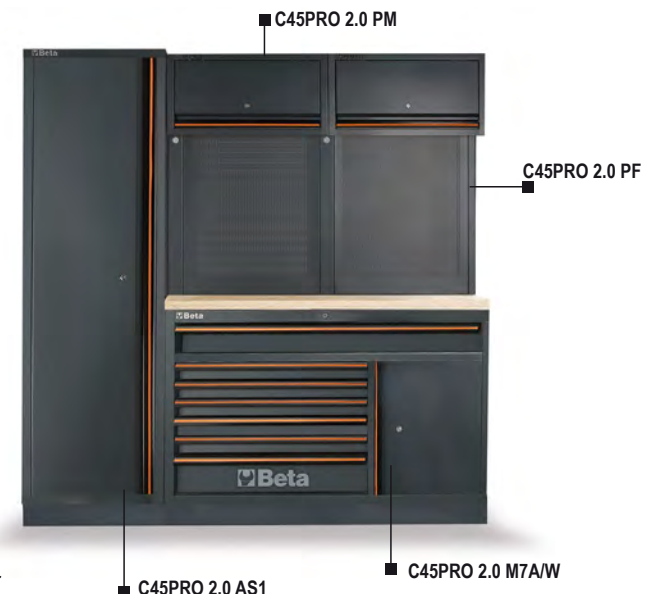

C45PRO 2.0 CX

workshop equipment combination C45PRO 2.0

Combination comprising the following:

- Stainless steel coated MDF worktop, dimensions 1,360x615 mm (C45PRO 2.0 PXE/2-1.3MT)
- Fixed service module (C45PRO 2.0 MS)
- Fixed module with 7 drawers (C45PRO 2.0 M7)
- 2 wall-mounted cabinets (C45PRO 2.0 PM)
- 2 perforated tool panels (C45PRO 2.0 PF)
- 2 wall brackets, wide type (C45PRO 2.0 SL)
- 1 wall bracket, narrow type (C45PRO 2.0 SS)
- Single-door cabinet (C45PRO 2.0 AS1)

225 kg

C45PRO 2.0 CX

1 045002023

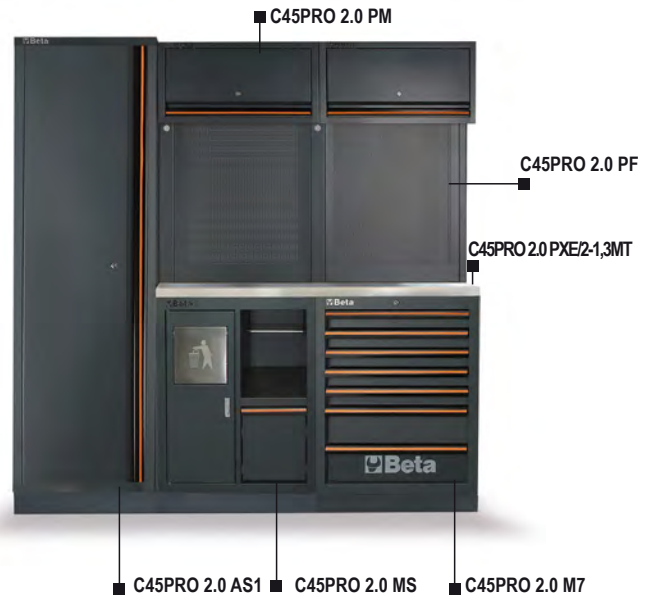

C45PRO 2.0 CW

workshop equipment combination C45PRO 2.0

Combination comprising the following:

- Multi-ply wood worktop, dimensions 1,360x615 mm (C45PRO 2.0 PWE/2-1.3MT)
- Fixed service module (C45PRO 2.0 MS)
- Fixed module with 7 drawers (C45PRO 2.0 M7)
- 2 wall-mounted cabinets (C45PRO 2.0 PM)
- 2 perforated tool panels (C45PRO 2.0 PF)
- 2 wall brackets, wide type (C45PRO 2.0 SL)
- 1 wall bracket, narrow type (C45PRO 2.0 SS)
- Single-door cabinet (C45PRO 2.0 AS1)

215 kg

C45PRO 2.0 CW

1 045002024

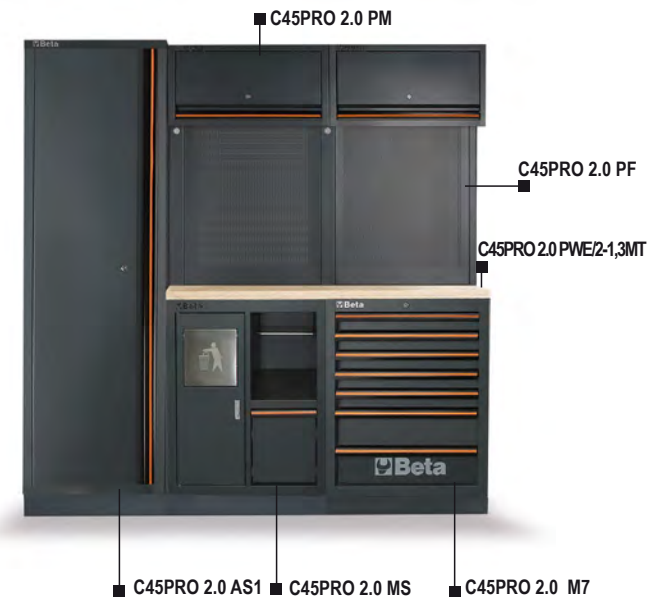

C45PRO 2.0 BPX-2,0

workshop equipment combination C45PRO 2.0

Combination comprising the following:

- Stainless steel coated MDF worktop, dimensions 2,040x615 mm (C45PRO 2.0 PXE/3-2.0MT)
- Fixed module with 7 drawers (C45PRO 2.0 M7)
- Fixed module with 5 drawers (C45PRO 2.0 M5)
- 3 perforated tool panels (C45PRO 2.0 PF)
- 2 wall brackets, wide type (C45PRO 2.0 SL)
- 2 wall brackets, narrow type (C45PRO 2.0 SS)

181 kg

C45PRO 2.0 BPX-2,0

1 045002042



C45PRO 2.0 BPW-2,0

workbenches for workshop equipment combination C45PRO 2.0

Combination comprising the following:

- Multi-ply wood worktop, dimensions 2,040x615 mm (C45PRO 2.0 PWE/3-2.0MT)
- Fixed module with 7 drawers (C45PRO 2.0 M7)
- Fixed module with 5 drawers (C45PRO 2.0 M5)
- 3 perforated tool panels (C45PRO 2.0 PF)
- 2 wall brackets, wide type (C45PRO 2.0 SL)
- 2 wall brackets, narrow type (C45PRO 2.0 SS)

165 kg

C45PRO 2.0 BPW-2,0

1 045002052

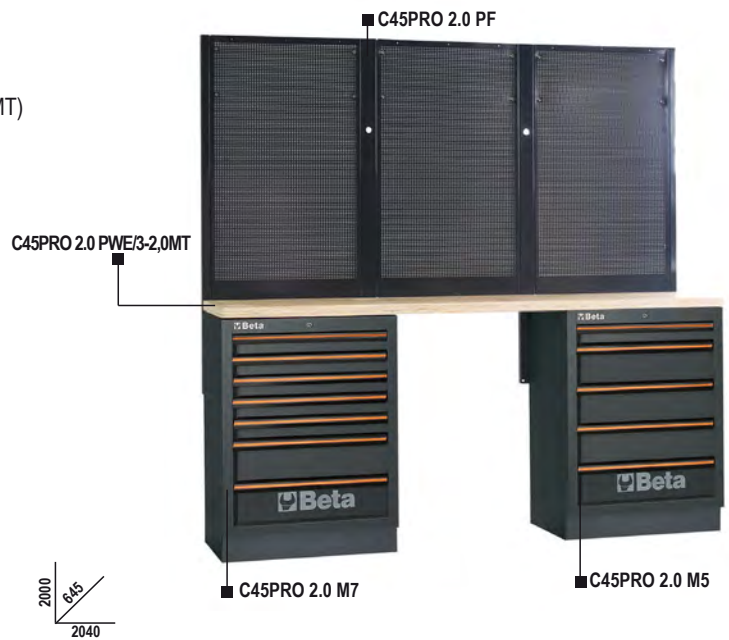

C45PRO 2.0 BPX-1,3

workshop equipment combination C45PRO 2.0

Combination comprising the following:

- Stainless steel coated MDF worktop, dimensions 1,360x615 mm (C45PRO 2.0 PXE/2-1.3MT)
- Fixed module with 7 drawers (C45PRO 2.0 M7)
- Fixed module with 5 drawers (C45PRO 2.0 M5)
- 2 perforated tool panels (C45PRO 2.0 PF)
- 1 wall bracket, wide type (C45PRO 2.0 SL)
- 2 wall brackets, narrow type (C45PRO 2.0 SS)

155 kg

C45PRO 2.0 BPX-1,3

1 045002041

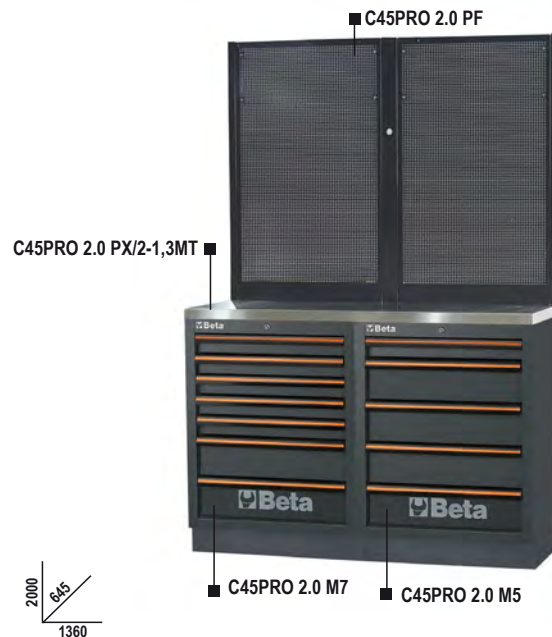

C45PRO 2.0 BPW-1,3

workshop equipment combination C45PRO 2.0

Combination comprising the following:

- Multi-ply wood worktop, dimensions 1,360x615 mm (C45PRO 2.0 PWE/2-1.3MT)
- Fixed module with 7 drawers (C45PRO 2.0 M7)
- Fixed module with 5 drawers (C45PRO 2.0 M5)
- 2 perforated tool panels (C45PRO 2.0 PF)
- 1 wall bracket, wide type (C45PRO 2.0 SL)
- 2 wall brackets, narrow type (C45PRO 2.0 SS)

145 kg

C45PRO 2.0 BPW-1,3

1 045002051

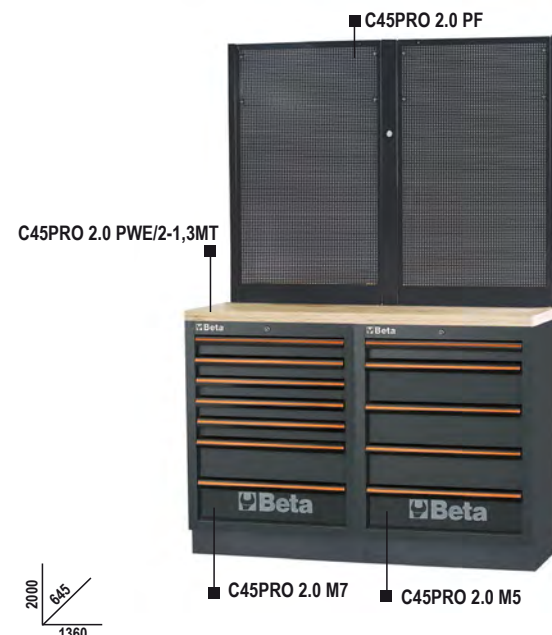

C45PRO 2.0 BLX

workbench for workshop equipment combination C45PRO 2.0

- Worktop (1,360x615 mm) made from stainless steel coated MDF
- Sheet metal framework
- With vertically adjustable feet
- Can accommodate a vice (1599P/150, to be ordered separately)
- To be used only as an addition to a workshop equipment combination, not as a stand-alone element



C45PRO 2.0 BLX



1

045002156

C45PRO 2.0 BLW

workbench for workshop equipment combination C45PRO 2.0

- Worktop (1,360x615 mm) made from multi-ply wood
- Sheet metal framework
- With vertically adjustable feet
- Can accommodate a vice (1599P/150, to be ordered separately)
- To be used only as an addition to a workshop equipment combination, not as a stand-alone element



C45PRO 2.0 BLW



1

045002157

C45PRO 2.0 M7A/X

fixed module with 7 drawers, for workshop equipment combination C45PRO 2.0

- Worktop (1,360x615 mm) made from stainless steel coated MDF
- 1 drawer (1,248x406 mm) with ball bearing slides
- 6 drawers (782x406 mm) with ball bearing slides:
 - 5 drawers 65 mm high
 - 1 drawer 145 mm high
- Drawer bases protected by foamed rubber mats
- Front centralized lock
- With vertically adjustable feet
- Can be fitted with thermoformed trays
- 1 storage compartment with intermediate shelf and door, interior dimensions 504x424x597 mm
- Can accommodate a vice (1599P/150, to be ordered separately)



81 kg

h	max
65 mm	25 kg
105 mm	40 kg
145 mm	30 kg

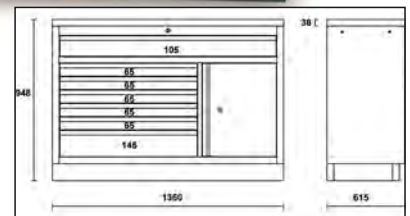

C45PRO 2.0 M7A/X



1

045002161

C45PRO 2.0 M7A/W

fixed module with 7 drawers, for workshop equipment combination
C45PRO 2.0

- Multi-ply wood worktop, 1,360x615 mm
- 1 drawer (1,248x406 mm) with ball bearing slides
- 6 drawers (782x406 mm) with ball bearing slides:
 - 5 drawers 65 mm high
 - 1 drawer 145 mm high
- Drawer bases protected by foamed rubber mats
- Front centralized lock
- With vertically adjustable feet
- Can be fitted with thermoformed trays
- 1 storage compartment with intermediate shelf and door, interior dimensions, 504x424x597 mm
- Can accommodate a vice (1599P/150, to be ordered separately)

80 kg

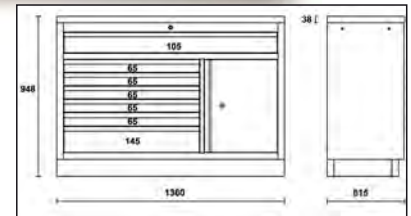

h		max
65 mm		25 kg
105 mm		40 kg
145 mm		30 kg

C45PRO 2.0 M7A/W

1 045002171

C45PRO 2.0 MWS/X

Work Station roller cab with 7 drawers and built-in waste bin

- worktop (1680 mm) made of stainless steel coated MDF
- 1 drawer (1248x406 mm) with ball bearing slides
- 6 drawers (782x406 mm) with ball bearing slides:
 - 5 drawers 65 mm high
 - 1 drawer 145 mm high
- drawer bases protected by foamed rubber mats
- can be fitted with thermoformed trays
- storage compartment with intermediate shelf and door, interior dimensions 504x424x597 mm
- built-in waste bin
- built-in paper roll compartment
- 4 heavy-duty castors, Ø 150 mm, 2 fixed and 2 steering with brakes
- front centralised lock
- can accommodate a vice (1599P/150, to be ordered separately)

126 kg

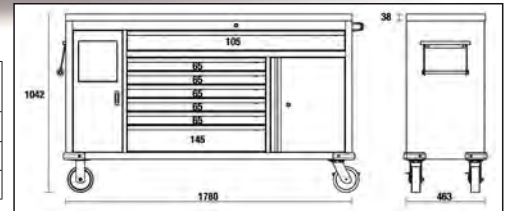

h		max
65 mm		25 kg
105 mm		40 kg
145 mm		30 kg

C45PRO 2.0 MWS/X

1 045000181

C45PRO 2.0 MWS/W

Work Station roller cab with 7 drawers and built-in waste bin

- multi-ply wood worktop (1680 mm)
- 1 drawer (1248x406 mm) with ball bearing slides
- 6 drawers (782x406 mm) with ball bearing slides:
 - 5 drawers 65 mm high
 - 1 drawer 145 mm high
- drawer bases protected by foamed rubber mats
- can be fitted with thermoformed trays
- storage compartment with intermediate shelf and door, interior dimensions 504x424x597 mm
- built-in waste bin
- built-in paper roll compartment
- 4 heavy-duty castors, Ø 150 mm, 2 fixed and 2 steering with brakes
- front centralised lock
- can accommodate a vice (1599P/150, to be ordered separately)

122 kg

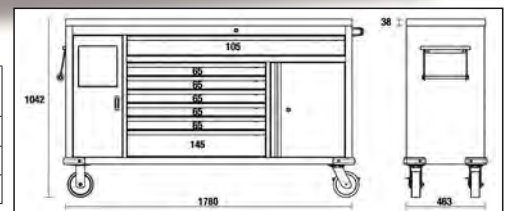

h		max
65 mm		25 kg
105 mm		40 kg
145 mm		30 kg

C45PRO 2.0 MWS/W

1 045000191

C45PRO 2.0 CPF

pair of perforated tool panels for mobile roller cab C45PRO MWS

Supplied complete with framework
50-hook GPS kit included

11 kg



C45PRO 2.0 CPF



1 045000195

C45PRO 2.0 PXE/1-0,7MT

worktop made from stainless steel coated MDF, 680x615 mm, for workbench, for workshop equipment combination C45PRO 2.0

- thickness: 38 mm
- can accommodate a vice (1599P/150, to be ordered separately)
- complete with 2 spacers and 2 exterior side pads



14 kg

C45PRO 2.0 PXE/1-0,7MT



1 045002131

C45PRO 2.0 PWE/1-0,7MT

worktop made from multi-ply wood, 680x615 mm, for workbench, for workshop equipment combination C45PRO 2.0

- thickness: 38 mm
- can accommodate a vice (1599P/150, to be ordered separately)
- complete with 2 spacers and 2 exterior side pads



8 kg

C45PRO 2.0 PWE/1-0,7MT



1 045002141

C45PRO 2.0 PXE/2-1,3MT

worktop made from stainless steel coated MDF, 1360x615 mm, for workbench, for workshop equipment combination C45PRO 2.0

- thickness: 38 mm
- can accommodate a vice (1599P/150, to be ordered separately)
- complete with 4 spacers and 2 exterior side pads



27 kg

C45PRO 2.0 PXE/2-1,3MT



1 045002133

C45PRO 2.0 PWE/2-1,3MT

worktop made from multi-ply wood, 1360x615 mm, for workbench, for workshop equipment combination C45PRO 2.0

- thickness: 38 mm
- can accommodate a vice (1599P/150, to be ordered separately)
- complete with 4 spacers and 2 exterior side pads



17 kg

C45PRO 2.0 PWE/2-1,3MT



1 045002143

C45PRO 2.0 PXE/3-2,0MT

worktop made from stainless steel coated MDF, 2040x615 mm, for workbench, for workshop equipment combination C45PRO 2.0

- thickness: 38 mm
- can accommodate a vice (1599P/150, to be ordered separately)
- complete with 6 spacers and 2 exterior side pads

41,5 kg



C45PRO 2.0 PXE/3-2,0MT

1 045002140

C45PRO 2.0 PWE/3-2,0MT

worktop made from multi-ply wood, 2040x615 mm, for workbench, for workshop equipment combination C45PRO 2.0

- thickness: 38 mm
- can accommodate a vice (1599P/150, to be ordered separately)
- complete with 6 spacers and 2 exterior side pads

26 kg



C45PRO 2.0 PWE/3-2,0MT

1 045002150

C45PRO 2.0 C5

mobile roller cab with 5 drawers, for workshop equipment combination C45PRO 2.0

- ABS worktop with anti-fall edges
- 5 drawers (532x406 mm) with ball bearing slides
- 4 swivel castors, Ø 100 mm (2 with brakes)
- Drawer bases protected by foamed rubber mats
- Front centralized lock
- Can be fitted with thermoformed trays
- Handles built into frame for improved ease of handling

46 kg

h	max
65 mm	25 kg
145 mm	30 kg

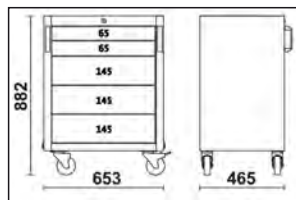
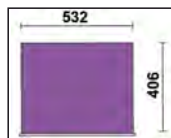

C45PRO 2.0 C5

1 045000226

 **Beta**

C45PRO 2.0 C7

mobile roller cab with 7 drawers, for workshop equipment combination
C45PRO 2.0

- ABS worktop with anti-fall edges
- 7 drawers (532x406 mm) with ball bearing slides
- 4 swivel castors, Ø 100 mm (2 with brakes)
- Drawer bases protected by foamed rubber mats
- Front centralized lock
- Can be fitted with thermoformed trays
- Handles built into frame for improved ease of handling

50 kg

h	max
65 mm	25 kg
145 mm	30 kg

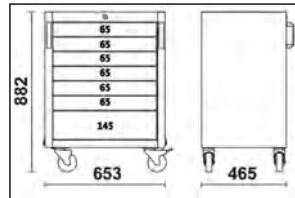
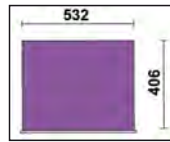

C45PRO 2.0 C7

1 045000228

C45PRO 2.0 M4

fixed module with 4 drawers, for workshop equipment combination
C45PRO 2.0

- 4 drawers (566x406 mm) with ball bearing slides
- Drawer bases protected by foamed rubber mats
- Front centralized lock
- With vertically adjustable feet
- Can be fitted with thermoformed trays

46,7 kg

h	max
65 mm	25 kg
145 mm	30 kg
225 mm	30 kg

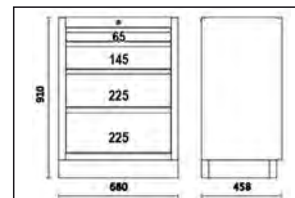
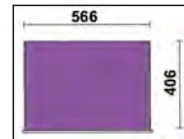

C45PRO 2.0 M4

1 045000234

C45PRO 2.0 M5

fixed module with 5 drawers, for workshop equipment combination
C45PRO 2.0

- 5 drawers (566x406 mm) with ball bearing slides
- Drawer bases protected by foamed rubber mats
- Front centralized lock
- With vertically adjustable feet
- Can be fitted with thermoformed trays

49,3 kg

h	max
65 mm	25 kg
145 mm	30 kg

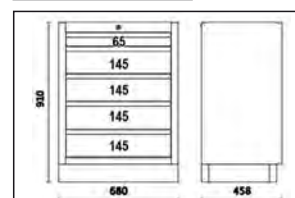

C45PRO 2.0 M5

1 045000235

C45PRO 2.0 M7

fixed module with 7 drawers, for workshop equipment combination
C45PRO 2.0

- 7 drawers (566x406 mm) with ball bearing slides
- Drawer bases protected by foamed rubber mats
- Front centralized lock
- With vertically adjustable feet
- Can be fitted with thermoformed trays

54,3 kg

h	max
65 mm	25 kg
145 mm	30 kg

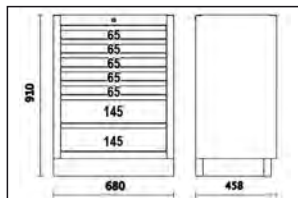
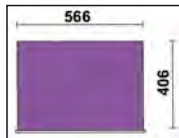

C45PRO 2.0 M7



1

045000237

C45PRO 2.0 M8

fixed module with 8 drawers, for workshop equipment combination
C45PRO 2.0

- 8 drawers (566x406 mm) with ball bearing slides
- Drawer bases protected by foamed rubber mats
- Front centralized lock
- With vertically adjustable feet
- Can be fitted with thermoformed trays

56,8 kg

h	max
65 mm	25 kg
145 mm	30 kg

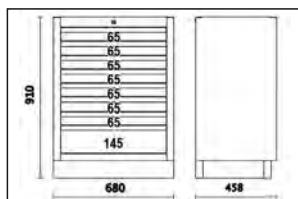
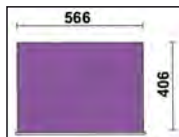

C45PRO 2.0 M8



1

045000238

C45PRO 2.0 MS

fixed service module, for workshop equipment combination C45PRO
2.0

- Built-in waste bin
- Paper roll compartment
- With vertically adjustable feet

37 kg

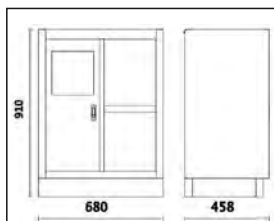

C45PRO 2.0 MS



1

045000239

C45PRO 2.0 RD/X

fixed sorted waste collection module, for workshop equipment combination C45PRO 2.0

- Stainless steel coated MDF worktop (1360x615 mm)
- Sturdy sheet metal frame complete with 4 containers with up-and-over door for sorting waste
- Each container is fitted with:
 - one removable plastic bin; capacity: 25 l
 - 4 swivel castors, Ø 60 mm
- Supplied with kit of 4 coloured adhesive tapes
- With vertically adjustable feet

80 kg

C45PRO 2.0 RD/X

1 045002241

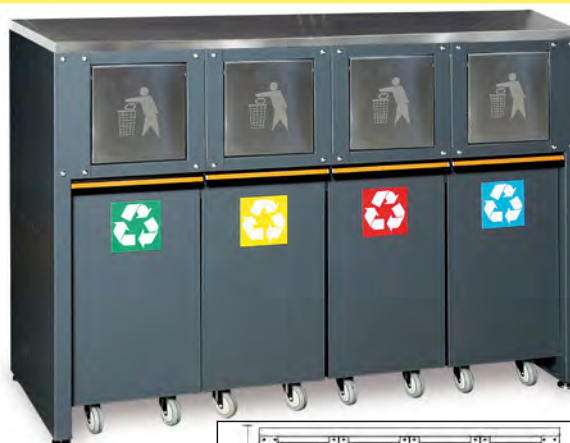

C45PRO 2.0 RD/X

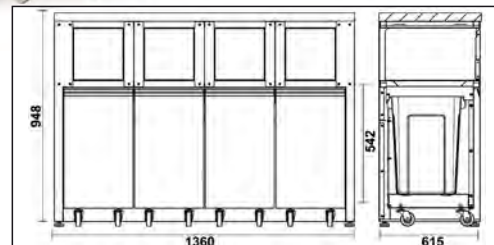

C45PRO 2.0 RD/W

fixed sorted waste collection module for workshop equipment combination C45PRO 2.0

- Multi-ply wood worktop (1,360x615 mm)
- Sturdy sheet metal frame complete with 4 containers with up-and-over door for sorting waste
- Each container is fitted with:
 - one removable plastic bin; capacity: 25 l
 - 4 swivel castors, Ø 60 mm
- Supplied with kit of 4 coloured adhesive tapes
- With vertically adjustable feet

80 kg

C45PRO 2.0 RD/W

1 045002240



C45PRO 2.0 RD/W

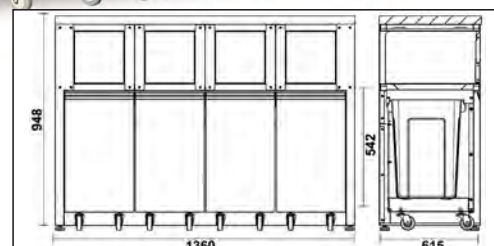

C45PRO 2.0 MA

fixed two-door module, for workshop equipment combination C45PRO 2.0

- With lock
- Vertically adjustable interior shelf
- Interior dimensions: 670x420 mm
- With vertically adjustable feet

29,4 kg

C45PRO 2.0 MA

1 045000232

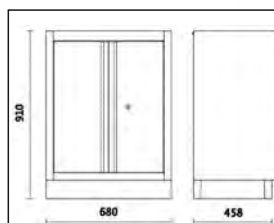

C45PRO 2.0 MAL

fixed module, 1360 mm long, with 2 sheet metal doors, for workshop equipment combination C45PRO 2.0

- With lock
- Vertically adjustable interior shelf
- Interior dimensions: 1,355x420 mm
- With vertically adjustable feet

44,8 kg

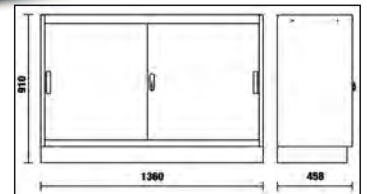

C45PRO 2.0 MAL

1 045000229

C45PRO 2.0 MAT

fixed module, 1360 mm long, with 2 clear polycarbonate doors, for workshop equipment combination C45PRO 2.0

- With lock
- Vertically adjustable interior shelf
- Interior dimensions: 1,355x420 mm
- With vertically adjustable feet

44,1 kg

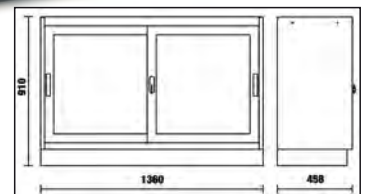

C45PRO 2.0 MAT

1 045000230

C45PRO 2.0 M3A

fixed module with 3 drawers and 2 doors, for workshop equipment combination C45PRO 2.0

- 3 drawers (566x406 mm) with ball bearing slides
- Drawer bases protected by foamed rubber mats
- Can be fitted with thermoformed trays
- Front centralized lock
- Storage compartment with double door and lock (interior dimensions 670x440 mm), complete with intermediate shelf
- With vertically adjustable feet

44 kg

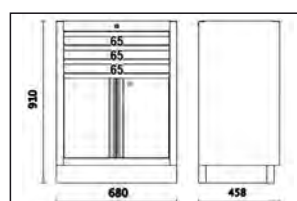
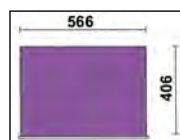

C45PRO 2.0 M3A

1 045000231

C45PRO 2.0 MRE

fixed module for charging power tools,
for workshop equipment combination C45PRO 2.0

- Pull-out side compartment with ball bearing slides, for storing power tools
- Fixed side compartment with door and lock for storing chargers and batteries, equipped with:
vertically adjustable shelf;
rubber-protected cable bushings;
ventilation slots;
- 1 drawer (256x400x190 mm), with ball bearing slides
- Front centralized lock
- Vertically adjustable feet

57 kg

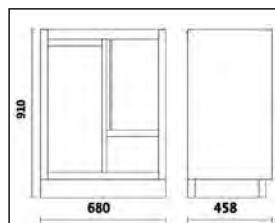

C45PRO 2.0 MRE

1 045000242

C45PRO 2.0 ML

fixed module with built-in sink, for workshop equipment combination
C45PRO 2.0

Technical specifications:

- Stainless steel basin
- Supplied complete with:
1 mixer tap
1 drain unit
1 sink stopper
1 filter cap
1 soap dispenser

Fixed two-door module with lock:

- Usable interior dimensions: 600x603x416 mm
- With vertically adjustable feet

44 kg

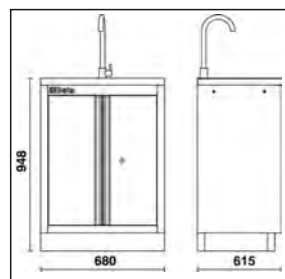

C45PRO 2.0 ML

1 045002233

C45PRO 2.0 ACT

fixed module with 3 drawers and 2 built-in reels,
for workshop equipment combination C45PRO 2.0

- 3 drawers (566x406 mm) with ball bearing slides
- Drawer bases protected by foamed rubber mats
- Front centralized lock
- With vertically adjustable feet

Supplied complete with:

- 1 built-in compressed air or cold water hose reel, 8 mm, length 10 m item 1900S 8x10
- 1 built-in cable reel, length 15 m, item 1844 15-H05

50,7 kg



h	max
65 mm	25 kg
145 mm	30 kg

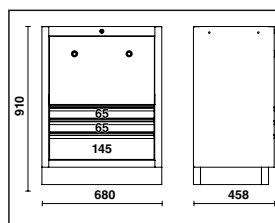
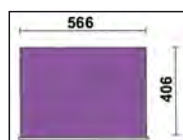

C45PRO 2.0 ACT

1 045000247

C45PRO 2.0 TC

fixed reel module with 3 drawers, for workshop equipment combination C45PRO 2.0, empty

- 3 drawers (566x406 mm) with ball bearing slides
 - Drawer bases protected by foamed rubber mats
 - Front centralized lock
 - With vertically adjustable feet
- Can accommodate 2 reels, to be chosen from the following:
- 2 compressed air or cold water hose reels, 8 mm, length 10 m item 1900S 8x10
 - 2 cable reels, to be chosen from the following items: 1843 15-H05, 1844 10-H05, 1844 15-H05, 1844 15-H07, 1845 12-H05, 1846 10-H05, 1846 10-H07 and 1846 15-H05
 - 1 compressed air or cold water hose reel, 8 mm, length 10 m item 1900S 8x10 and 1 cable reel, to be chosen from the above-mentioned items

h		
	65 mm	25 kg
	145 mm	30 kg

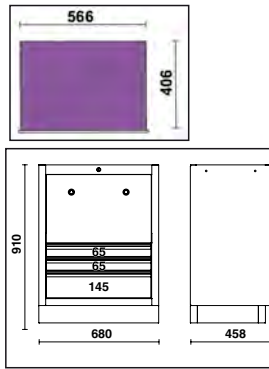

📦 40,9 kg

C45PRO 2.0 TC



1

045000249

C45PRO 2.0 T3

3-tier tool trolley, for workshop equipment combination C45PRO 2.0

- 4 swivel castors, Ø 100 mm (one with brake)
- Static load capacity: 200 kg (distributed over 3 shelves)

📦 19,2 kg

C45PRO 2.0 T3



1

045000250

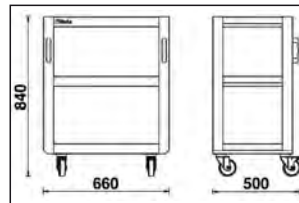

C45PRO 2.0 SS

side wall brackets, narrow type, for workshop equipment combination C45PRO 2.0

- Dimensions: 1420x32.5x30 mm

📦 1,5 kg

C45PRO 2.0 SS



1

045000333



C45PRO 2.0 SL

side wall brackets, wide type, for workshop equipment combination C45PRO 2.0

- Dimensions: 1420x65x30 mm

📦 2 kg

C45PRO 2.0 SL



1

045000366

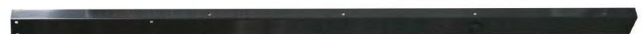

C45PRO 2.0 PAS

tool wall system, for workshop equipment combination C45PRO 2.0

- Aluminium shutter, vertically adjustable, with lock
- Two removable perforated tool panels
- Can be used in combination with 1.3-m-long workbench
- 50-hook GPS kit included

49,7 kg

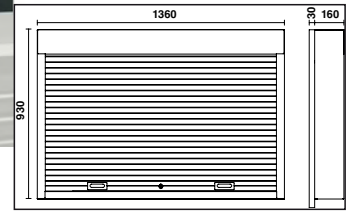

C45PRO 2.0 PAS

1 045000290

C45PRO 2.0 PF

perforated tool panel, for workshop equipment combination C45PRO 2.0

- Dimensions: 1052x614.5x24 mm

5,3 kg

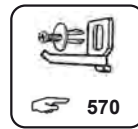

C45PRO 2.0 PF

1 045000313

C45PRO 2.0 PFE

perforated tool panel, for workshop equipment combination C45PRO 2.0

- Dimensions: 1052x614.5x24 mm
- Can be fitted with 1 power socket (not included)

5,3 kg



C45PRO 2.0 PFE

1 045000312

C45PRO 2.0 MP

sheet metal shelf for perforated tool panels, for workshop equipment combination C45PRO 2.0

Dimensions: 614x160x80 mm

2,1 kg



C45PRO 2.0 MP

1 045000315

C45PRO 2.0 CORNER/X

self-supporting complete corner, for workshop equipment combination
C45PRO 2.0

- Suspended corner cabinet with lock and 2 storage compartments
- 2 perforated tool panels (1,052x800 mm)
- Stainless steel coated MDF corner worktop (1,018x1,018 mm)
- Lower corner module with large storage compartment
- With vertically adjustable feet

127 kg

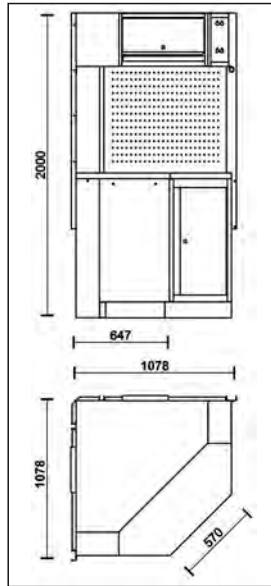

C45PRO 2.0 CORNER/X

1 045002401

C45PRO 2.0 CORNER/W

self-supporting complete corner, for workshop equipment combination
C45PRO 2.0

- Suspended corner cabinet with lock and 2 storage compartments
- 2 perforated tool panels (1,052x800 mm)
- Multi-ply wood corner worktop (1,018x1,018 mm)
- Lower corner module with large storage compartment
- With vertically adjustable feet

119 kg

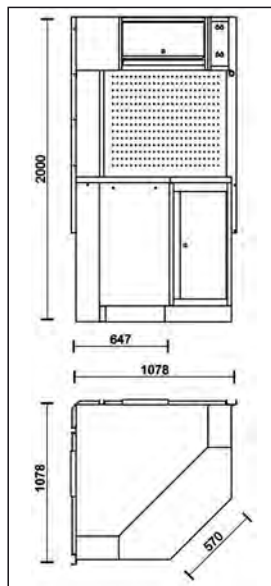

C45PRO 2.0 CORNER/W

1 045002411

Beta

C45PRO 2.0 CAI/X

lower corner module, for workshop equipment combination C45PRO 2.0

- Stainless steel coated MDF corner worktop (1,018x1,018 mm)
- Fixed corner module with large storage compartment
- With vertically adjustable feet

77 kg

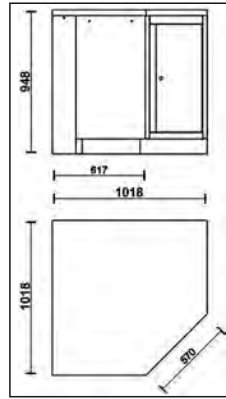

C45PRO 2.0 CAI/X

1 045002412

C45PRO 2.0 CAI/W

lower corner module, for workshop equipment combination C45PRO 2.0

- Multi-ply wood corner worktop (1,018x1,018 mm)
- Fixed corner module with large storage compartment
- With vertically adjustable feet

69 kg

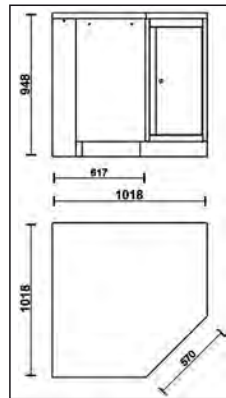

C45PRO 2.0 CAI/W

1 045002402

C45PRO 2.0 PM

wall-mounted cabinet, for workshop equipment combination C45PRO 2.0

- Cabinet length: 680 mm
- With gas springs, making it easier to open and close door
- With lock

10 kg

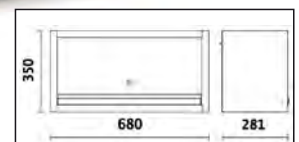

C45PRO 2.0 PM

1 045000302

SSPE

under-cabinet support for power tools

- For use only under suspended cabinet C45PRO 2.0 PM (workshop equipment C45PRO 2.0)
- With 5 convenient slots for accommodating power tools
- Dimensions: 680 x 280 x 150 mm

6 kg



SSPE

1 088880482

C45PRO 2.0 PML

wall-mounted cabinet, long, for workshop equipment combination
C45PRO 2.0

- Cabinet length: 1360 mm
- With gas springs, making it easier to open and close door
- With lock

17 kg

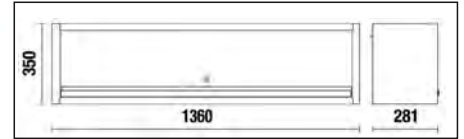

C45PRO 2.0 PML

1 045000303

C45PRO 2.0 AS1

sheet metal single-door tool cabinet with bracket, for workshop equipment combination C45PRO 2.0

- 4 removable, vertically adjustable shelves
- Convenient folding clothes rail under first shelf
- With lock
- Sheet metal door can be installed with right or left opening
- Interior dimensions: 590x430 mm
- With vertically adjustable feet

57,5 kg

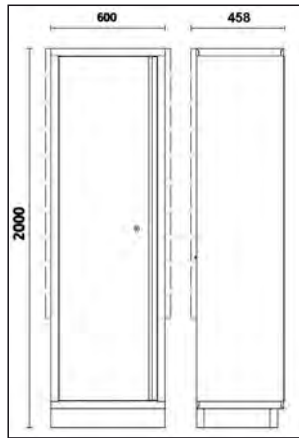

C45PRO 2.0 AS1

1 045000451

C45PRO 2.0 A1/R600

interior shelf for tool cabinet C45PRO AS1

2,5 kg



C45PRO 2.0 A1/R600

1 045000466

C45PRO 2.0 A1/RB600

interior shelf for tool cabinet C45PRO 2.0 AS1, with clothes rail

3,3 kg



C45PRO 2.0 A1/RB600

1 045000467

C45PRO 2.0 AS2

sheet metal two-door tool cabinet with bracket, for workshop equipment combination C45PRO 2.0

- 4 removable, vertically adjustable shelves
- With lock
- Sheet metal door can be installed with right or left opening
- Interior dimensions: 910x430 mm
- With vertically adjustable feet

80 kg

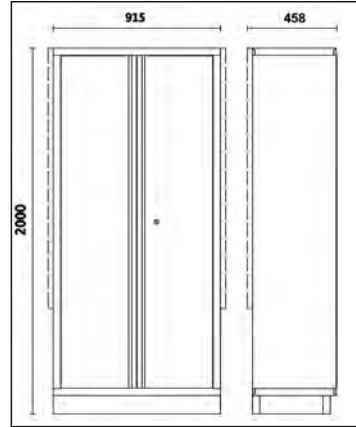

C45PRO 2.0 AS2

1 045000481

C45PRO 2.0 AS2/3C

sheet metal two-door tool cabinet with 3 drawers and bracket, for workshop equipment combination C45PRO 2.0

- 4 removable, vertically adjustable shelves
- **Supplied complete with 3-drawer (681x360 mm) module**
- Front lock
- Sheet metal door can be installed with right or left opening
- Interior dimensions: 910x430 mm
- With vertically adjustable feet

100,5 kg

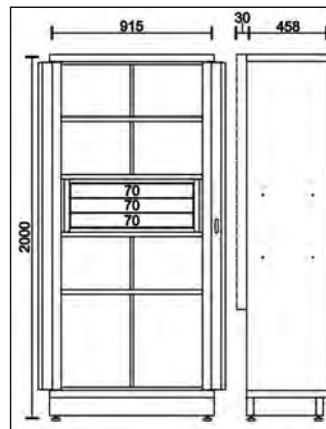
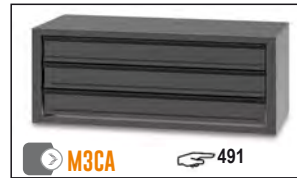

C45PRO 2.0 AS2/3C

1 045000482

C45PRO 2.0 A2/R915

Interior shelf for tool cabinet C45PRO 2.0 AS2

4,5 kg

50 kg



C45PRO 2.0 A2/R915

1 045000496

C45STR

coloured adhesive tape, for workshop equipment combination C45PRO 2.0

- Allows tailoring of colour of horizontal and vertical inserts in workshop equipment combination C45PRO 2.0



	L m		
C45STR-O/2011	30	1	045000911
C45STR-G/9006	25	1	045000912
C45STR-R/3000	25	1	045000913
C45STR-B/5015	25	1	045000914
C45STR-Y/1023	25	1	045000915
C45STR-V/6029	25	1	045000916

S4CB

wide-span shelving, 4 shelves,
basic shelving

A must-have for optimizing and efficiently managing products and tools in warehouses, workshops, offices and sales points. Made from sturdy sheet steel, it is ideal for accommodating several different types of goods.

- Carrying capacity of each shelf: 250 kg
- Total carrying capacity: 1,000 kg
- Can be fixed to floor

82 kg



	mm		
S4CB	1552x600x1803mm	1	088880490

S4CA

wide-span shelving, 4 shelves,
additional shelving

Additional shelving extends basic shelving to increase storage space. Made from sturdy sheet steel, it is ideal for accommodating several different types of goods.

- Carrying capacity of each shelf: 250 kg
- Total carrying capacity: 1,000 kg
- Can be fixed to floor

72 kg



S4CA		1	088880495



ACCESSORIES RSC55 - RSC50 2.0 - C45PRO 2.0

		5000 RSC50 2.0/PLED-ST	5000 RSC50 2.0/PLED	5000 RSC50 2.0/ASL	5000 RSC50 2.0/CTR
	A	1x	-	1x	-
	B	-	1x	1x	1x
	A	1x	1x	1x	-
	B	-	2x	1x	1x
	A	1x	2x	1x	-
	B	-	3x	1x	1x

5000 RSC50 2.0/PLEDC

aluminium profile with LED strip, for workshop equipment combinations

To be applied under worktops, under/in suspended cabinets, under shelves and linear/corner guards, to light working areas.

Features:

- 6.5W IP20 LED strip; length: 50 cm
- Supplied complete with cables
- Convenient fixing through magnets

80 g



5000 RSC50 2.0/PLEDC

1 050001712

5000 RSC50 2.0/PLED-ST

aluminium profile with LED strip and SOFT TOUCH switch, for workshop equipment combination

To be applied under worktops, under/in suspended cabinets, under shelves and linear/corner guards, to light working areas.

Features:

- 6.5W IP20 LED strip; length: 50 cm
- On/off and brightness adjustment SOFT TOUCH switch
- Supplied complete with cables
- Convenient fixing through magnets

80 g



5000 RSC50 2.0/PLED-ST

1 050001715

5000 RSC50 2.0/ASL

power supplier for LED strip, for workshop equipment combination

Features:

- 24VDC 22W power supplier
- Can supply power to max. 3 6.5W LED strips

210 g



5000 RSC50 2.0/ASL

1 050001716

5000 RSC50 2.0/CTR

LED strip controller, with RF remote control, for workshop equipment combination

For use only with LED strip item 5000 RSC50 2.0/PLEDC

Kit contents:

1 mini receiver

1 wireless RF remote control

Specifications of mini receiver:

Input voltage: 5V -24VDC

Rated output current: 5A

Peak output current: 12A

Operating temperature: -20 °C ÷ +35 °C

Specifications of RF remote control:

ON/OFF button

BRIGHT +/- button: allows manual brightness adjustment

25%/50%/100% button: allows automatic brightness adjustment

Battery: 3V CR2025 (included)

Dimensions: 86 (L) x 40 (W) x 7 (H) mm

Integrated features:

- Memory
- Mode (manual/automatic brightness)
- Brightness adjustment



25 g

5000 RSC50 2.0/CTR



1



050001721

CPMB/3C

workbench small parts containers with 3 drawers

- Outer frame made of PP
- Small parts drawers made of PET
- Stackable

Specifications of drawers:

• Interior drawer dimensions: 160x107x105h mm

• Unbreakable

• Glass effect transparency unchanged over time

• Scratchproof

• Resistant to oil, acids and aggressive chemicals

• Also suitable for use in food products



2,3 kg

CPMB/3C



1



088880443

KIT 6VC/3C

kit of 6 removable trays for small parts containers CPMB/3C

1,1 kg



6x



KIT 6VC/3C



1



088880453

CPMB/5C

workbench small parts containers with 5 drawers

- Outer frame made of PP
- Small parts drawers made of PET
- Stackable

Specifications of drawers:

- Interior drawer dimensions: 90x86x62h mm
- Unbreakable
- Glass effect transparency unchanged over time
- Scratchproof
- Resistant to oil, acids and aggressive chemicals
- Also suitable for use in food products

1,7 kg

CPMB/5C

1 088880445



KIT 10VC/5C

kit of 10 removable trays for small parts containers CPMB/5C

800 g

KIT 10VC/5C

1 088880455



PM/5C

wall-mounted small parts holder with 5 tote trays, made from plastic, with support

- Interior dimensions: 95x120 mm
- Can be used with tool wall systems: C45PRO, RSC50 2.0 e RSC55 2.0

2,7 kg

PM/5C

1 088880450



PM/6C

wall-mounted smallwares holder with 6 tote trays, made from plastic, with support

- Interior dimensions: 80x60 mm
- Can be used with tool wall systems C45PRO 2.0, RSC50 2.0 and RSC55

970 g

PM/6C

1 088880440



CP

wall-mounted bottle rack, made from steel

- Can be used with wall-mounted tool panels
- Supplied complete with 2 supports

533 g

CP

1 088880470



SPC

computer wall bracket

- Matches tool wall systems RSC55, RSC50 2.0 and C45PRO 2.0
- Dimensions 398x243x138 mm

1,5 kg



SPC

1 088880480

SP5S

wall-mounted support with 5 compartments

- Made from sheet metal
- 5 tool compartments varying in height
- Dimensions: 260x60x290 mm

1,8 kg



SP5S

1 088880475

M3CA

3-drawer module
for two-door tool cabinets C45PRO AS2 and RSC50 A2

- 3 fully removable (661x360 mm), with ball bearing slides
- Drawer height: 78 mm
- Drawer bases protected by foamed rubber mats
- Supplied complete with assembly kit

20,5 kg



295
400
750

M3CA

1 088880485

Beta